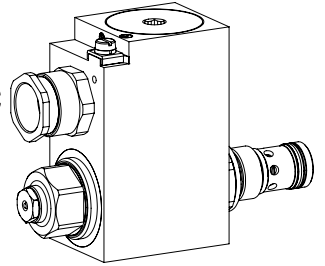

Proportional 2-way flow control cartridge

- ◆ direct operated
- ◆ $Q_{max} = 28 \text{ l/min}$
- ◆ $Q_{Nmax} = 25 \text{ l/min}$
- ◆ $p_{max} = 350 \text{ bar}$

M22 x 1,5
ISO 7789

- ⊕ II 2 G Ex db IIC T6, T4
- ⊕ II 2 D Ex tb III C T80 °C, T130 °C
- ⊕ I M2 Ex db I Mb
- Class I Division 1
- Class I Zone 1

DESCRIPTION

Direct operated, pressure compensated proportional flow control valve in screw-in cartridge construction for cavity according to ISO 7789. With the solenoid deenergised, the control spool is held in the closed position by a spring. The change of the electric current is followed by a proportional volume flow change. From the input (1), the fluid flows over a throttle and a control spool to the controlled output (2). The pressure tight encapsulated Ex-protection solenoid coil prevents an explosion on the inside penetrating to the outside as well as an ignitable surface temperature.

APPLICATION

Proportional flow control valves are suitable for precise speed control, where the load current has to be maintained constant independent of the input and output pressure. These valves are suitable for applications in explosion-hazard areas, open cast and also in mines. The screw-in cartridge is perfectly suitable for installation in control blocks. For machining the cartridge cavity in steel and aluminum blocks, cavity tools are available (hire or purchase). Please refer to the data sheets in register 2.13.

TYPE CODE

		Q		N		B		PM22		-		/		-		#	
Flow control valve																	
Normally closed																	
Proportional, Ex-protection execution Ex d																	
Screw-in cartridge M22 x 1,5																	
Nominal volume flow rate Q_N	3,2 l/min	<input type="text" value="3,2"/>	16 l/min	<input type="text" value="16"/>	8 l/min	<input type="text" value="8"/>	25 l/min	<input type="text" value="25"/>									
Nominal voltage U_N	12 VDC	<input type="text" value="G12"/>	24 VDC	<input type="text" value="G24"/>													
Nominal power P_N	15 W	<input type="text" value="L15"/>	17 W	<input type="text" value="L17"/>	Ambient temperature up to: 70 °C 70 °C (only UL / CSA)												
Certification	ATEX, IECEx, EAC, CCC Australia	<input type="text" value="AU"/>	UL / CSA	<input type="text" value="UL"/>	MA	<input type="text" value="MA"/>											
Sealing material	NBR	<input type="text" value=""/>	FKM (Viton)	<input type="text" value="D1"/>													
Options	without amplifier	<input type="text" value="M248"/>															
Design index (subject to change)																	

2.6-634

SYMBOL

Simplified

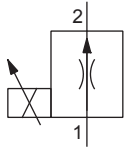

Detailed QN...

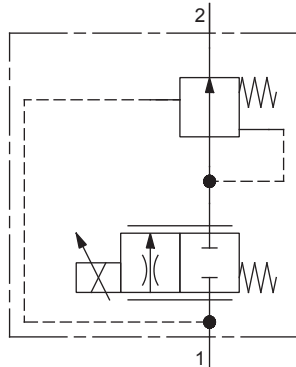
GENERAL SPECIFICATIONS

Designation	Proportional 2-way flow control valve
Construction	Direct operated
Mounting	Screw-in cartridge construction
Nominal size	M22 x 1,5 according to ISO 7789
Actuation	Ex-protection proportional solenoid
Ambient temperature	Operation as T4 -25...+70 °C (L15 / L17)
Weight	1,85 kg
MTTFd	150 years

HYDRAULIC SPECIFICATIONS

Working pressure	$p_{max} = 350 \text{ bar}$
Maximum volume flow	$Q_{max} = 28 \text{ l/min}$
Minimum volume flow	$Q_{min} = 0,1 \text{ l/min}$
Volume flow direction	1 → 2
Leakage oil	See characteristics
Nominal volume flow range	$Q_N = 3,2; 8; 16; 25 \text{ l/min}$
Hysteresis	≤ 7 % at optimal dither signal
Repeatability	≤ 3 % at optimal dither signal
Fluid	Mineral oil, other fluid on request
Viscosity range	12 mm ² /s...320 mm ² /s
Temperature range fluid	Operation as T4 NBR -25...+70 °C (L15 / L17) FKM -20...+70 °C (L15 / L17)
Contamination efficiency	Class 18 / 16 / 13
Filtration	Required filtration grade $\beta_{6...10} \geq 75$, see data sheet 1.0-50

CERTIFICATES

	Surface	Mining	Standard -25 °C to...	M248 Electronic
ATEX	x	x	x	x
IECEX	x	x	x	x
CCC	x	x	x	x
EAC	x	x	x	x
Australia	x	x	x	
MA		x	x	x
UL / CSA	x		x	

 The certificates can be found on www.wandfluh.com
ACTUATION

Actuation	Proportional solenoid, wet pin push type, pressure tight
Execution	MKY45 / 18x60 (data sheet 1.1-183) MKU45 / 18x60 (data sheet 1.1-184)
Connection	Cable gland for cable $\varnothing 6,5...14 \text{ mm}$

Attention! The UL execution is always supplied without cable gland



ELECTRICAL SPECIFICATIONS

Protection class	IP65 / 66 / 67
Relative duty factor	100 % DF
Voltage tolerance	± 10 % with regard to nominal voltage
Standard nominal voltage	12 VDC, 24 VDC
Limiting current at 50 °C	L15 / 17, 50 °C $I_G = 950 \text{ mA (12 VDC)}$ $I_G = 450 \text{ mA (24 VDC)}$ L15 / 17, 70 °C $I_G = 910 \text{ mA (12 VDC)}$ $I_G = 420 \text{ mA (24 VDC)}$
Standard nominal power	15 W, 17 W
Temperature class	Nominal power 15 W / 17 W: T1...T4

Note! Other electrical specifications see data sheet 1.1-183 and 1.1-184

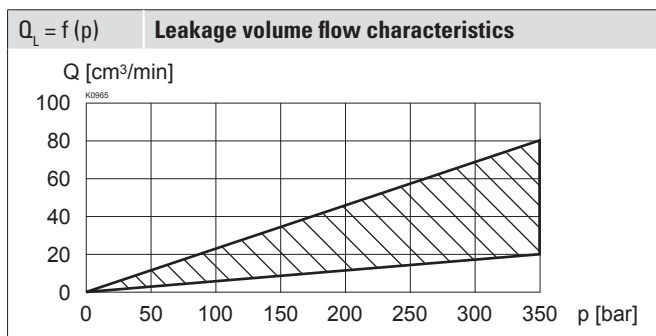
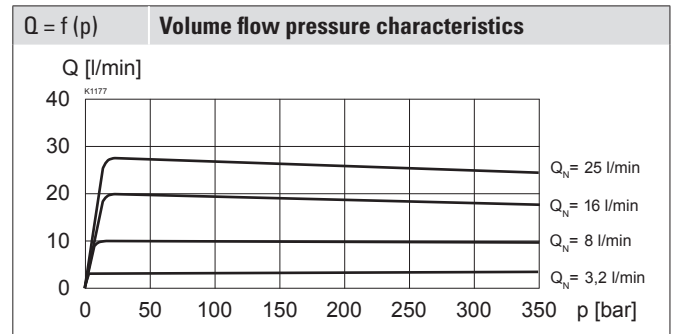
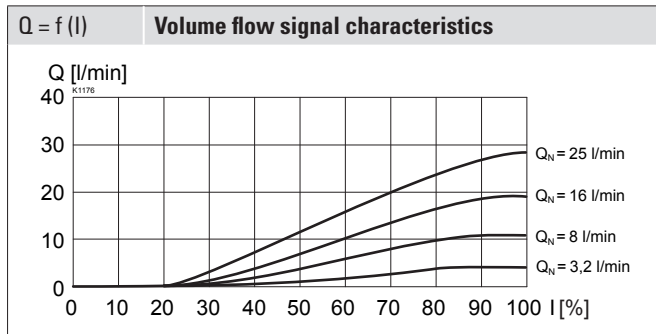

PERFORMANCE SPECIFICATIONS

 Oil viscosity $\nu = 30 \text{ mm}^2/\text{s}$

ACCESSORIES

Proportional amplifier	Register 1.13
Flange body / sandwich plate NG4-Mini	Data sheet 2.6-820
Flange body / sandwich plate NG6	Data sheet 2.6-840
Threaded body	Data sheet 2.9-205
Technical explanations	Data sheet 1.0-100
Filtration	Data sheet 1.0-50

MANUAL OVERRIDE

HB4,5 as standard

SURFACE TREATMENT

- ◆ The cartridge body is gas-nitro-carburised
- ◆ The armature tube and the slip-on coil are zinc- / nickel-coated

SEALING MATERIAL

NBR or FKM (Viton) as standard, choice in the type code

DIMENSIONS

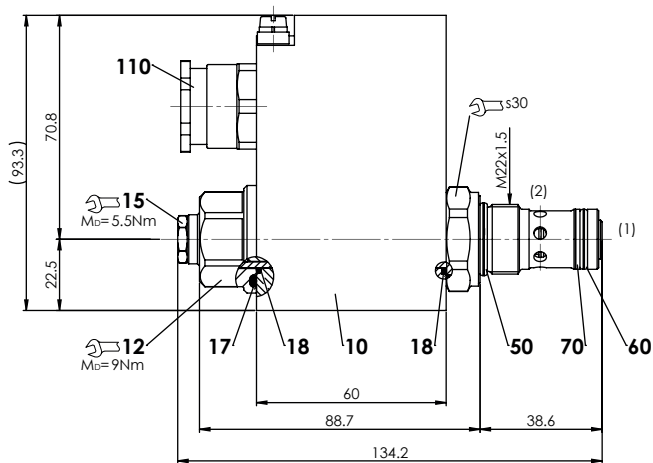

Dimensions of the solenoid coil see data sheet 1.1-183 and 1.1-184

HYDRAULIC CONNECTION

Cavity drawing according to ISO 7789-22-01-0-98

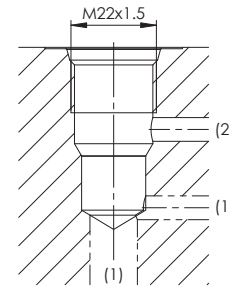

Note!



For detailed cavity drawing and cavity tools see data sheet 2.13-1008

PARTS LIST

Position	Article	Description
10	263.6...	Solenoid coil MK.45 / 18 x 60
12	154.2603	Knurled nut Ex M18 x 1,5 x 18
15	253.8000	Manual override HB4,5
17	160.2251	O-ring ID 25,07 x 2,62 (NBR)
18	160.2170	O-ring ID 17,17 x 1,78 (NBR)
50	160.2188	O-ring ID 18,77 x 1,78 (NBR)
	160.6188	O-ring ID 18,77 x 1,78 (FKM)
60	160.2156	O-ring ID 15,60 x 1,78 (NBR)
	160.6156	O-ring ID 15,60 x 1,78 (FKM)
70	049.3196	Backup ring rd 16,1 x 19 x 1,4
110	111.1080	Cable gland M20 x 1,5

STANDARDS

Cartridge cavity	ISO 7789
Explosion protection	Directive 2014 / 34 / EU (ATEX)
Flameproof enclosure	EN / IEC / UL 60079-1, 31
Cable entry	EN 60079-0, 1, 7, 15, 31
Protection class	EN 60 529
Contamination efficiency	ISO 4406

INSTALLATION NOTES

Mounting type	Screw-in cartridge M22 x 1,5
Mounting position	Any, preferably horizontal
Tightening torque	$M_D = 60 \text{ Nm}$ Screw-in cartridge $M_D = 5 \text{ Nm}$ knurled nut