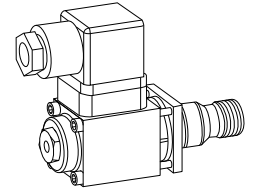

**Proportional throttle valve**
**Screw-in cartridge**

- Direct operated, not pressure compensated
- Throttle in one flow direction
- $Q_{max} = 12 \text{ l/min}$ ,  $p_{max} = 250 \text{ bar}$
- $Q_{Nmax} = 6,3 \text{ l/min}$

**M18x1,5**  
 ISO 7789

**DESCRIPTION**

Direct operated proportional throttle valve. Thread M18x1,5 and cavity in accordance with ISO 7789. Spool options „normally closed“ and „normally open“. Two flow ranges are available. The volume flow is adjusted by a Wandfluh-proportional solenoid (VDE standard 0580). Progressive increase and decrease of volume flow and reduced hysteresis are characteristics of this valve. The cartridge body is made of steel. Its special surface coating protects the outside against corrosion and reduces friction of the control spool. The solenoid is zinc coated.

**FUNCTION**

The force controlled wet pin proportional solenoid acts directly on the control spool which opens or closes the throttle segments of the radial holes in the valve body. The throttle opening and therefore the flow volume changes proportionally to the current input to the proportional solenoid. With deenergised solenoid the control spool is held in closed respectively open position by a spring. To control the valve proportional amplifiers are available from Wandfluh (see register 1.13).

**APPLICATION**

Proportional throttle valves are suitable for precise feed control systems. Very sensitive opening and closing characteristics allow smooth control of movements in stationary or mobile installations, e.g. machine tools, public vehicles. Installation of the screw-in cartridge in control blocks as well as in the Wandfluh sandwich plates (vertical stacked systems) and flange valves of the NG3-Mini types. (Please note the separate data sheets in register 2.6). Cavity tools are available for machining the cavities in steel and aluminium (hire or purchase). Please refer to the data sheets in register 2.13.

**TYPE CODE**

		D	<input type="checkbox"/>	P	PM18	-	<input type="checkbox"/>	-	<input type="checkbox"/>	#	<input type="checkbox"/>
Throttle valve											
Normally closed	<input type="checkbox"/>	N									
Normally open	<input type="checkbox"/>	O									
Proportional											
Screw-in cartridge M18x1,5											
Nominal volume flow rate $Q_N$	4 l/min	<input type="checkbox"/>	4								
	6,3 l/min	<input type="checkbox"/>	6,3								
Nominal voltage $U_N$	12 VDC	<input type="checkbox"/>	G12								
	24 VDC	<input type="checkbox"/>	G24								
Design-Index (Subject to change)											

**GENERAL SPECIFICATIONS**

Description	Direct operated proportional throttle valve
Construction	Screw-in cavity acc. to ISO 7789
Operations	Proportional solenoid
Befestigungsart	Screw-in thread M18x1,5
Ambient temperature	-20...50 °C
Mounting position	any
Fastening torque	$M_D = 30 \text{ Nm}$ for screw-in cartridge $M_D = 1,2 \text{ Nm}$ (Qual. 8.8) for solenoid screws
Weight	$m = 0,25 \text{ kg}$
Volume flow direction	1 → 2

**HYDRAULIC SPECIFICATIONS**

Fluid	Mineral oil, other fluid on request
Contamination efficiency	ISO 4406:1999, class 18/16/13 (Required filtration grade $\beta_{6...10} \geq 75$ ) see data sheet 1.0-50/2
Viscosity range	12 mm <sup>2</sup> /s...320 mm <sup>2</sup> /s
Fluid temperature	-20...+70 °C
Peak pressure	$p_{max} = 250 \text{ bar}$
Nominal volume flow rates	$Q_N = 4 \text{ l/min}$ , $Q_N = 6,3 \text{ l/min}$ at 10 bar pressure drop
Max. Volume flow	$Q_{max} = 12 \text{ l/min}$
Leakage volume flow	see characteristics
Resolution	1 mA
Repeatability	≤ 1% *
Hysteresis	≤ 2% *
	* at optimal dithersignal

**ELECTRICAL SPECIFICATIONS**

Construction	Proportional solenoid, wet pin push type, pressure tight.	
Standard-Nominal voltage	$U_N = 12 \text{ VDC}$	$U_N = 24 \text{ VDC}$
Limiting current	$I_G = 1080 \text{ mA}$	$I_G = 540 \text{ mA}$
Relative duty factor	100% DF (see data sheet 1.1-430)	
Protection class	IP 65 to EN 60 529	
Connection/Power supply	Over device plug connection to ISO 4400 / DIN 43 650 (2P+E)	
Other electrical specifications	see data sheet 1.1-90 (PI29V)	

**SYMBOLS**

Normally closed

Normally open

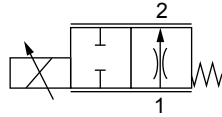
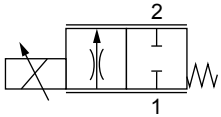
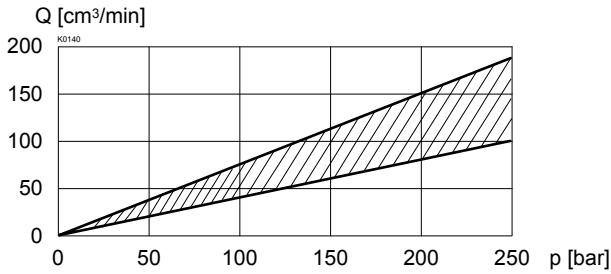
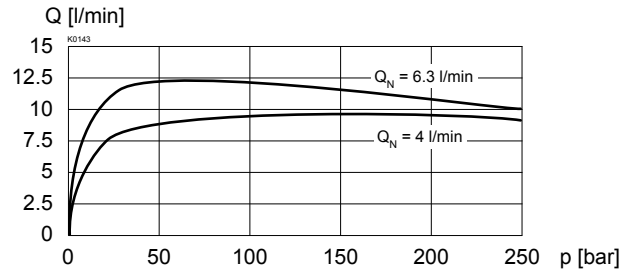
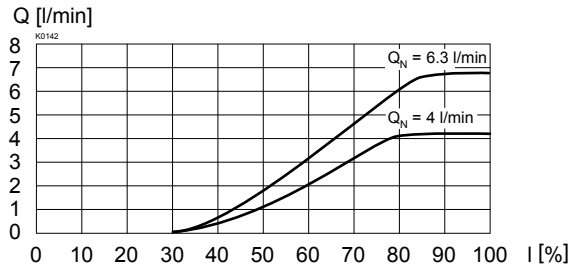
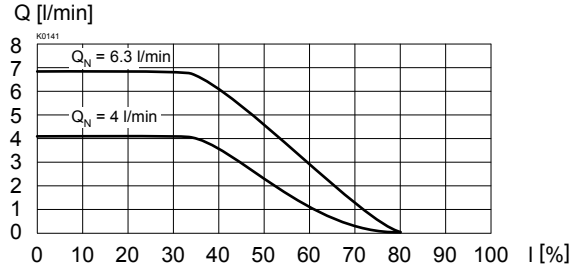
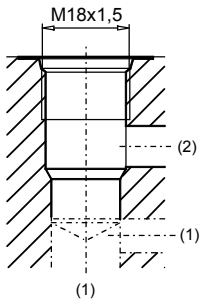
**CHARACTERISTICS** Oil viscosity  $\nu = 30 \text{ mm}^2/\text{s}$ 
 $Q_L = f(p)$  Leakage volume flow characteristics

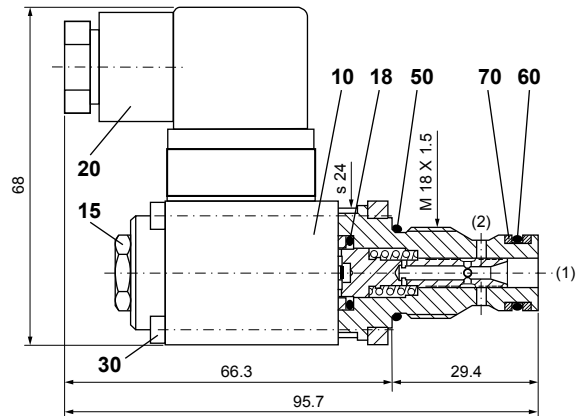
 $Q = f(p)$  Volume flow pressure characteristics

 $Q = f(I)$  Volume flow adjustment characteristics  
 DNPPM18

 $Q = f(I)$  Volume flow adjustment characteristics  
 DOPPM18

**DIMENSIONS / SECTIONAL DRAWINGS**

 Cavity drawing according to  
 ISO 7789-18-01-0-98

 For detailed cavity drawing  
 and cavity tools see data  
 sheet 2.13-1002.

**PARTS LIST**

Position	Article	Description
10	256.2453	Proportional solenoid PI29V-G24
	256.2418	Proportional solenoid PI29V-G12
15	253.8000	Mounted screw with integrated manual override HB4,5
18	160.2120	O-ring ID 12,42x1,78
20	219.2002	Plug (black)
30	246.0146	Socket head cap screw M3x45 DIN912
50	160.2156	O-ring ID 15,60x1,78
60	160.2111	O-ring ID 11,11x1,78
70	049.3156	Back up ring RD 12,1x15x1,4

**ACCESSORIES**

Flange/sandwich plate NG3-Mini	Data sheet 2.6-700
Line mount body Data sheet	2.9-205
Proportional amplifier	Register 1.13
Mating connector EN 175301-803	Article Nr. 219.2002

Technical explanation see data sheet 1.0-100