

Proportional pressure reducing cartridge

- ◆ pilot operated
- ◆ $Q_{\max} = 250 \text{ l/min}$
- ◆ $p_{\max} = 400 \text{ bar}$
- ◆ $p_{N \text{ red max}} = 350 \text{ bar}$

M42 x 2
ISO 7789

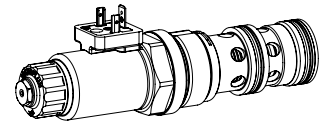

DESCRIPTION

Pilot operated proportional pressure reducing valve in screw-in cartridge construction for cavity according to ISO 7789. Proportionally to the solenoid current, the solenoid force and the pressure in port A (1) rise. The valve functions practically independently of the pressure in port P (2). Pressure increase in the consumer port A (1) to above the adjusted value, e.g. through an active consumer, is avoided by discharging excess oil to the tank T (3). With the solenoid deenergised, the oil flows freely from port P (2) to consumer port A (1). For the control, Wandfluh proportional amplifiers are available (see register 1.13).

APPLICATION

The electrical remote control in conjunction with process controls allows economical solutions with repeatable processes. The screw-in cartridge is perfectly suitable for installation in control blocks. For machining the cartridge cavity in steel and aluminum blocks, cavity tools are available (hire or purchase). Please refer to the data sheets in register 2.13.

SYMBOL

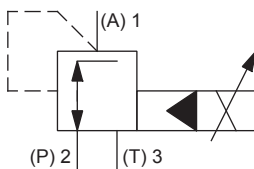

ACTUATION

Actuation	Proportional solenoid, wet pin push type, pressure tight
Execution	W.S37 / 19 x 50 (Data sheet 1.1-173) M.S35 / 19 x 50 (Data sheet 1.1-174)
Connection	Connector socket EN 175301 – 803 Connector socket AMP Junior-Timer Connector Deutsch DT04 – 2P

STANDARDS

Cartridge cavity	ISO 7789
Solenoids	DIN VDE 0580
Connection execution D	EN 175301 – 803
Protection class	EN 60 529
Contamination efficiency	ISO 4406

INSTALLATION NOTES

Mounting type	Screw-in cartridge M42 x 2
Mounting position	Any, preferably horizontal
Tightening torque	$M_D = 100 \text{ Nm}$ Screw-in cartridge $M_D = 5 \text{ Nm}$ knurled nut $M_D = 9,5 \text{ Nm}$ HB0 $M_D = 5,5 \text{ Nm}$ HB4,5

TYPE CODE

		M V P PM42 - <input type="text"/> - <input type="text"/> / <input type="text"/> <input type="text"/> - <input type="text"/> <input type="text"/> # <input type="text"/>			
Pressure reducing valve					
Pilot operated					
Proportional					
Screw-in cartridge M42 x 2					
Nominal pressure range $p_{N\text{red}}$	100 bar <input type="text"/> 200 bar <input type="text"/>	275 bar <input type="text"/> 350 bar <input type="text"/>			
Nominal voltage U_N	12 VDC <input type="text"/> 24 VDC <input type="text"/> without coil <input type="text"/>				
Slip-on coil	Metal housing round <input type="text"/> Metal housing square <input type="text"/>				
Connection execution	Connector socket EN 175301-803 / ISO 4400 <input type="text"/> Connector socket AMP Junior - Timer <input type="text"/> Connector Deutsch DT04 - 2P <input type="text"/>				
Sealing material	NBR <input type="text"/> FKM (Viton) <input type="text"/>				
Manual override	Manual override <input type="text"/> Screw plug <input type="text"/>				
Design index (subject to change)					

2.3-690

GENERAL SPECIFICATIONS

Designation	Proportional pressure reducing valve
Construction	Pilot operated
Mounting	Screw-in cartridge construction
Nominal size	M42 x 2 according to ISO 7789
Actuation	Proportional solenoid
Ambient temperature	-25...+70 °C
Weight	1,05 kg
MTTFd	150 years

ELECTRICAL SPECIFICATIONS

Protection class	Connection execution D: IP65 Connection execution J: IP66 Connection execution G: IP67 and IP69K
Relative duty factor	100 % DF
Standard nominal voltage	12 VDC, 24 VDC
Limiting current at 50 °C	$I_G = 1320 \text{ mA } (U_N = 12\text{VDC})$ $I_G = 660 \text{ mA } (U_N = 24\text{VDC})$

Note! Other electrical specifications see data sheet 1.1-173 (slip-on coil W) and 1.1-174 (slip-on coil M)

HYDRAULIC SPECIFICATIONS

Working pressure	$p_{\text{max}} = 400 \text{ bar}$
Nominal pressure range	$P_{N\text{red}} = 100; 200; 275; 350 \text{ bar}$
Volume flow range	$Q = 0 \dots 250 \text{ l/min}$
Leakage oil	See characteristics
Hysteresis	$\leq 5 \%$ at optimal dither signal
Repeatability	$\leq 2 \%$ at optimal dither signal
Fluid	Mineral oil, other fluid on request
Viscosity range	$12 \text{ mm}^2/\text{s} \dots 320 \text{ mm}^2/\text{s}$
Temperature range fluid	-25...+70 °C (NBR) -20...+70 °C (FKM)
Contamination efficiency	Class 18 / 16 / 13
Filtration	Required filtration grade $\beta_{6 \dots 10} \geq 75$, see data sheet 1.0-50

PERFORMANCE SPECIFICATIONS

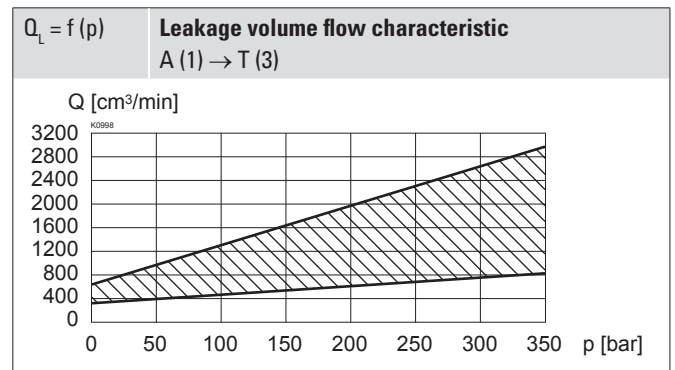
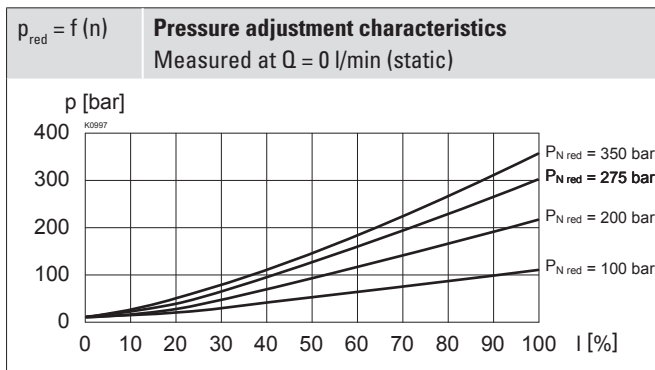
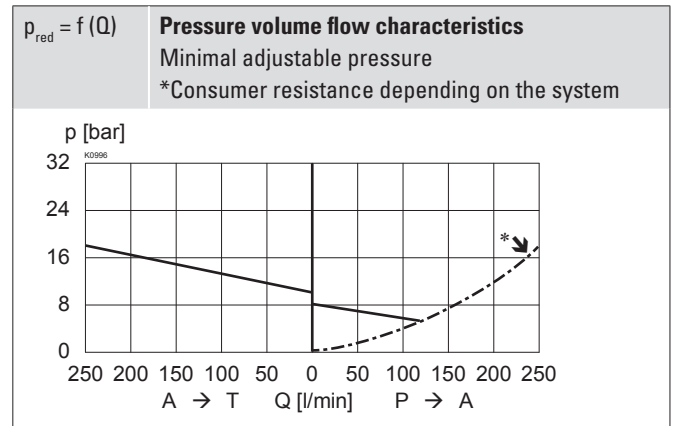
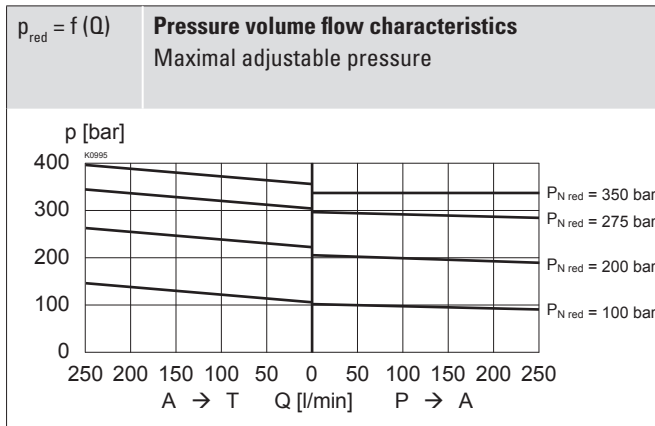
 Oil viscosity $\nu = 30 \text{ mm}^2/\text{s}$

ACCESSORIES

Proportional amplifier	Register 1.13
Electric plug B (black)	Article no. 219.2002
Threaded body	Data sheet 2.9-210
Technical explanations	Data sheet 1.0-100
Hydraulic fluids	Data sheet 1.0-50
Filtration	Data sheet 1.0-50

SURFACE TREATMENT

- ◆ The cartridge body, the slip-on coil and the armature tube are zinc-nickel coated

MANUAL OVERRIDE

- HB4,5
- Optionally: Screw plug (HB0), no actuation possible

SEALING MATERIAL

- NBR or FKM (Viton) as standard, choice in the type code

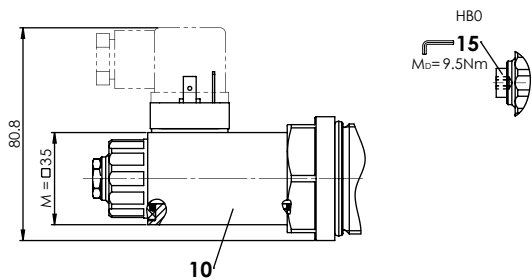
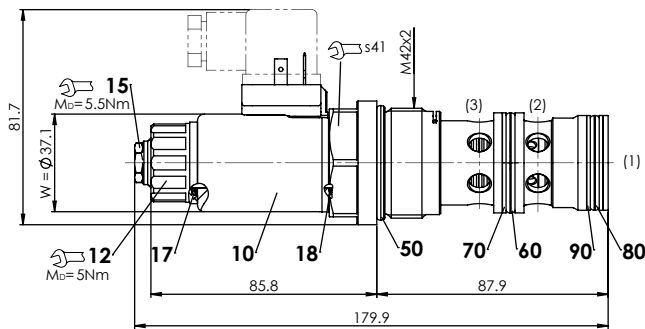
DIMENSIONS

HYDRAULIC CONNECTION

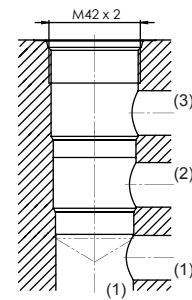
Cavity drawing according to ISO 7789-42-04-0-07

Note!

For detailed cavity drawing and cavity tools see data sheet 2.13-1047

PARTS LIST

Position	Article	Description
10	206.2...	W.S37 / 19 x 50
	260.5...	M.S35 / 19 x 50
12	154.2700	Knurled nut
15	253.8000	HB4,5 manual override
	239.2033	HBO Screw plug
17	160.2187	O-ring ID 18,72 x 2,62 (NBR)
18	160.2170	O-ring ID 17,17 x 1,78 (NBR)
50	160.2377	O-ring ID 37,77 x 2,62 (NBR)
	160.8378	O-ring ID 37,77 x 2,62 (FKM)
60	160.2329	O-ring ID 32,99 x 2,62 (NBR)
	160.6325	O-ring ID 32,99 x 2,62 (FKM)
70	049.3384	Backup ring rd 33,5 x 38 x 1,4
80	160.2314	O-ring ID 31,42 x 2,62 (NBR)
	160.6315	O-ring ID 31,42 x 2,62 (FKM)
90	049.3364	Back-up ring rd 31,5 x 36 x 1,4