

## Proportional pressure reducing cartridge

- ◆ pilot operated
- ◆  $Q_{\max} = 160 \text{ l/min}$
- ◆  $p_{\max} = 400 \text{ bar}$
- ◆  $p_{N \text{ red max}} = 350 \text{ bar}$

## DESCRIPTION

Pilot operated proportional pressure reducing valve in screw-in cartridge construction for cavity according to ISO 7789. Proportionally to the solenoid current, the solenoid force and the pressure in port A (1) rise. The valve functions practically independently of the pressure in port P (2). Pressure increase in the consumer port A (1) to above the adjusted value, e.g. through an active consumer, is avoided by discharging excess oil to the tank T (3). With the solenoid deenergised, the oil flows freely from port P (2) to consumer port A (1). For the control, Wandfluh proportional amplifiers are available (see register 1.13). The pressure tight encapsulated Ex-protection solenoid coil prevents an explosion on the inside penetrating to the outside as well as an ignitable surface temperature.

## SYMBOL

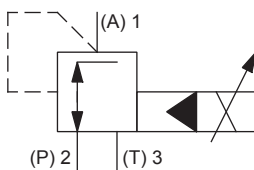

## GENERAL SPECIFICATIONS

Designation	Proportional pressure reducing valve
Construction	Pilot operated
Mounting	Screw-in cartridge construction
Nominal size	M33 x 2 according to ISO 7789
Actuation	Proportional solenoid
Ambient temperature	<b>Operation as T6</b> -25...+40 °C (L9) <b>Operation as T4</b> -25...+90 °C (L9) -25...+70 °C (L15 / L17)
Weight	2,4 kg
MTTFd	150 years

## M33 x 2 ISO 7789

- ⊕ II 2 G Ex db IIC T6, T4
  - ⊕ II 2 D Ex tb III C T80 °C, T130 °C
  - ⊕ I M2 Ex db I Mb
- Class I Division 1  
Class I Zone 1

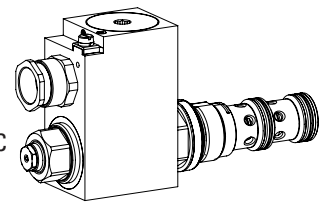

## APPLICATION

These valves are suitable for applications in explosion-hazard areas, open cast and also in mines. The electrical remote control in conjunction with process controls allows economical solutions with repeatable processes. The screw-in cartridge is perfectly suitable for installation in control blocks and is installed in sandwich- (vertical stacked systems) and in flange plates (corresponding data sheets in this register). For machining the cartridge cavity in steel and aluminum blocks, cavity tools are available (hire or purchase). Please refer to the data sheets in register 2.13.

## CERTIFICATES

	Surface	Mining	Standard -25 °C to...	M248 Electronic
ATEX	x	x	x	x
IECEx	x	x	x	x
CCC	x	x	x	x
EAC	x	x	x	x
Australia	x	x	x	
MA		x	x	x
UL / CSA	x		x	

The certificates can be found on [www.wandfluh.com](http://www.wandfluh.com)

## ACTUATION

Actuation	Proportional solenoid, wet pin push type, pressure tight
Execution	MKY45 / 18x60 (data sheet 1.1-183) MKU45 / 18x60 (data sheet 1.1-184)
Connection	Cable gland for cable $\varnothing 6,5 \dots 14 \text{ mm}$

**Attention!** The UL execution is always supplied without cable gland



**TYPE CODE**

		M V B PM33 - <input type="text"/> - <input type="text"/> / <input type="text"/> / <input type="text"/> - <input type="text"/> <input type="text"/> # <input type="text"/>			
Pressure reducing valve	<input type="checkbox"/>				
Pilot operated	<input type="checkbox"/>				
Proportional, explosion proof execution Ex d	<input type="checkbox"/>				
Screw-in cartridge M33 x 2	<input type="checkbox"/>				
Execution	L9		L15 / L17		
Nominal pressure range $p_{N\text{red}}$ [bar]	<input type="text" value="80"/>	<input type="text" value="220"/>	<input type="text" value="100"/>	<input type="text" value="275"/>	
	<input type="text" value="160"/>	<input type="text" value="280"/>	<input type="text" value="200"/>	<input type="text" value="350"/>	
Nominal voltage $U_N$	12 VDC	<input type="text" value="G12"/>			
	24 VDC	<input type="text" value="G24"/>			
Nominal power $P_N$	9 W	<input type="text" value="L9"/>	<i>Ambient temperature up to:</i>		
	15 W	<input type="text" value="L15"/>	40 °C or 90 °C		
	17 W	<input type="text" value="L17"/>	70 °C		
			70 °C (only UL / CSA)		
Certification	ATEX, IECEx, EAC, <input type="checkbox"/>		UL / CSA	<input type="text" value="UL"/>	
	CCC		MA	<input type="text" value="MA"/>	
	Australia	<input type="text" value="AU"/>			
Sealing material	NBR	<input type="checkbox"/>			
	FKM (Viton)	<input type="text" value="D1"/>			
Options	without amplifier	<input type="checkbox"/>			
		<input type="text" value="M248"/>			
Design index (subject to change)					

2.3-654

**HYDRAULIC SPECIFICATIONS**

Working pressure	$p_{\text{max}} = 400 \text{ bar}$
Nominal pressure range	<b>Execution L9</b> $P_{N\text{red}} = 80 \text{ bar}, 160 \text{ bar}, 220 \text{ bar}, 280 \text{ bar}$ <b>Execution L15 / L17</b> $P_{N\text{red}} = 100 \text{ bar}, 200 \text{ bar}, 275 \text{ bar}, 350 \text{ bar}$
Volume flow range	$Q = 0 \dots 160 \text{ l/min}$
Leakage oil	See characteristics
Hysteresis	$\leq 5\%$ at optimal dither signal
Repeatability	$\leq 2\%$ at optimal dither signal
Fluid	Mineral oil, other fluid on request
Viscosity range	$12 \text{ mm}^2/\text{s} \dots 320 \text{ mm}^2/\text{s}$
Temperature range fluid	<b>Operation as T6</b> NBR $-25 \dots +40 \text{ }^\circ\text{C}$ (L9) FKM $-20 \dots +40 \text{ }^\circ\text{C}$ (L9) <b>Operation as T4</b> NBR $-25 \dots +70 \text{ }^\circ\text{C}$ (L9 or L15 / L17) FKM $-20 \dots +70 \text{ }^\circ\text{C}$ (L15 / L17) FKM $-20 \dots +70 \text{ }^\circ\text{C}$ (L9)
Contamination efficiency	Class 18 / 16 / 13
Filtration	Required filtration grade $\beta 6 \dots 10 \geq 75$ , see data sheet 1.0-50

**ELECTRICAL SPECIFICATIONS**

Protection class	IP65 / 66 / 67
Relative duty factor	100 % DF
Voltage tolerance	$\pm 10\%$ with regard to nominal voltage
Standard nominal voltage	12 VDC, 24 VDC
Limiting current at... °C	<b>L9, 40 °C</b> $I_G = 625 \text{ mA}$ (12 VDC) $I_G = 305 \text{ mA}$ (24 VDC) <b>L15 / 17, 50 °C</b> $I_G = 950 \text{ mA}$ (12 VDC) $I_G = 450 \text{ mA}$ (24 VDC) <b>L15 / 17, 70 °C</b> $I_G = 910 \text{ mA}$ (12 VDC) $I_G = 420 \text{ mA}$ (24 VDC)
Standard nominal power	9 W, 15 W, 17 W
Temperature class	Nominal power 9 W: T1...T6 Nominal power 15 W / 17 W: T1...T4

**Note!**

Other electrical specifications see data sheet 1.1-183 and 1.1-184

**PERFORMANCE SPECIFICATIONS EXECUTION L9 (MEASURED AT 40 °C)**

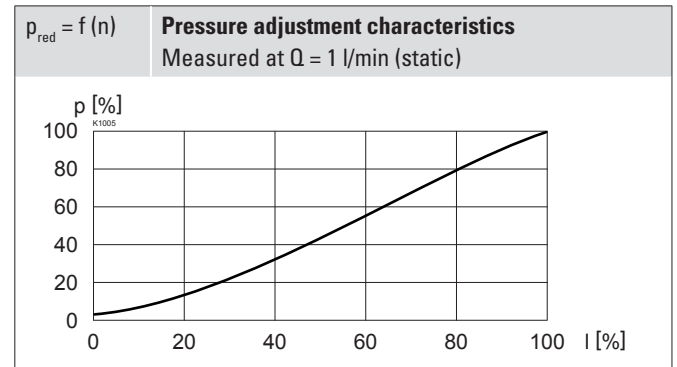
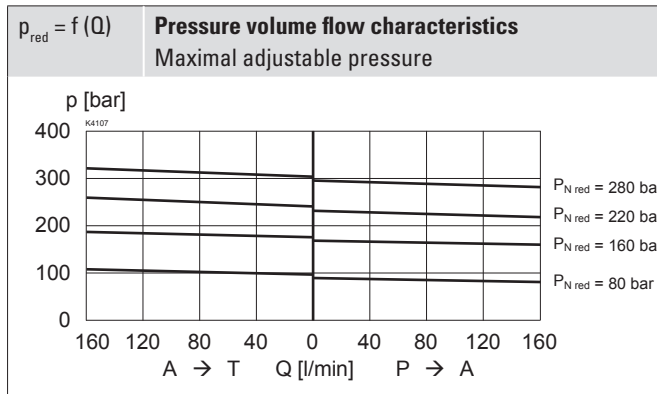
 Oil viscosity  $\nu = 30 \text{ mm}^2/\text{s}$ 

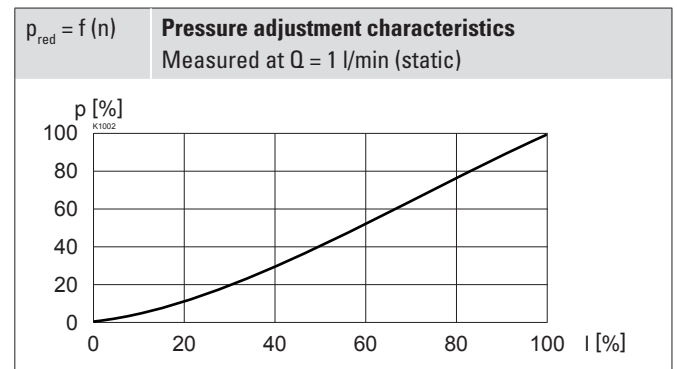
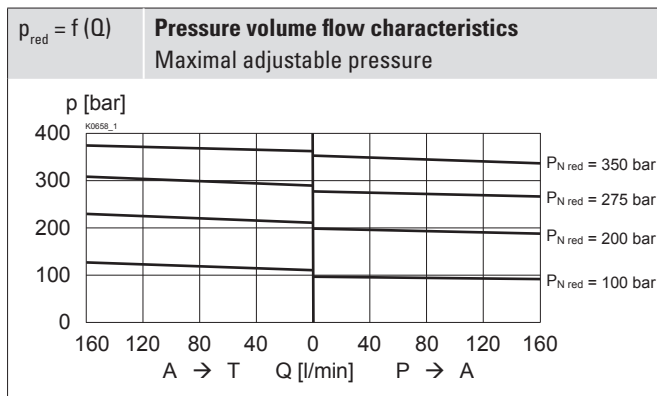
**PERFORMANCE SPECIFICATIONS EXECUTION L15 / L17 (MEASURED AT 50 °C)**

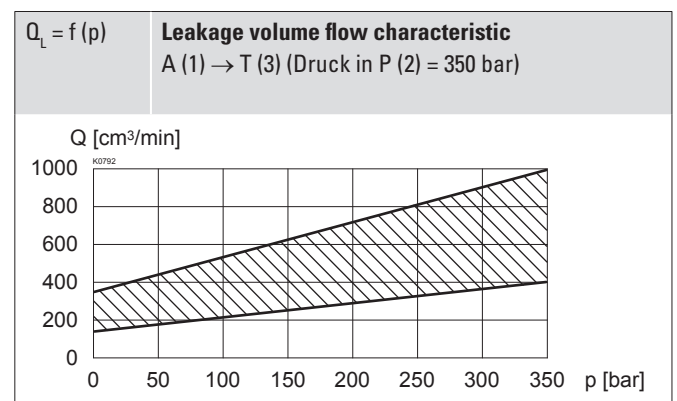
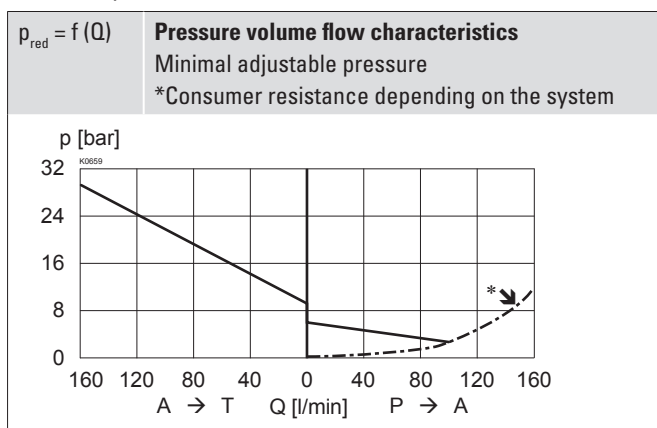
 Oil viscosity  $\nu = 30 \text{ mm}^2/\text{s}$ 

**PERFORMANCE SPECIFICATIONS**

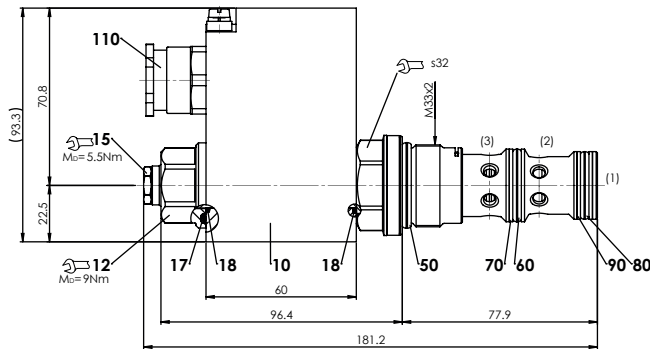
 Oil viscosity  $\nu = 30 \text{ mm}^2/\text{s}$ 

## DIMENSIONS



## HYDRAULIC CONNECTION

Cavity drawing according to ISO 7789-33-04-0-98

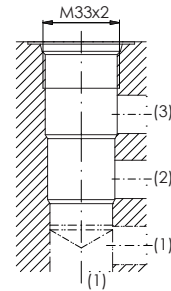
**Note!**

For detailed cavity drawing and cavity tools see data sheet 2.13-1040

## PARTS LIST

Position	Article	Description
10	263.6...	Solenoid coil MK.45 / 18 x 60
12	154.2603	Knurled nut Ex M18 x 1,5 x 18
15	253.8000	Manual override HB4,5
17	160.2251	O-ring ID 25,07 x 2,62 (NBR)
18	160.2170	O-ring ID 17,17 x 1,78 (NBR)
50	160.2298	O-ring ID 29,82 x 2,62 (NBR)
	160.6296	O-ring ID 29,82 x 2,62 (FKM)
60	160.2235	O-ring ID 23,47 x 2,62 (NBR)
	160.6235	O-ring ID 23,47 x 2,62 (FKM)
70	049.3297	Backup ring rd 24,5 x 29 x 1,4
80	160.2219	O-ring ID 21,89 x 2,62 (NBR)
	160.6216	O-ring ID 21,89 x 2,62 (FKM)
90	049.3277	Backup ring rd 22,5 x 27 x 1,4
110	111.1080	Cable gland M20 x 1,5

## ACCESSORIES

Proportional amplifier	Register 1.13
Threaded body	Data sheet 2.9-210
Technical explanations	Data sheet 1.0-100
Filtration	Data sheet 1.0-50

## MANUAL OVERRIDE

HB4,5 as standard

## SEALING MATERIAL

NBR or FKM (Viton) as standard, choice in the type code

## STANDARDS

Cartridge cavity	ISO 7789
Explosion protection	Directive 2014 / 34 / EU (ATEX)
Flameproof enclosure	EN / IEC / UL 60079-1, 31
Cable entry	EN 60079-0, 1, 7, 15, 31
Protection class	EN 60 529
Contamination efficiency	ISO 4406

## INSTALLATION NOTES

Mounting type	Screw-in cartridge M33 x 2
Mounting position	Any, preferably horizontal
Tightening torque	$M_D = 80$ Nm Screw-in cartridge $M_D = 9$ Nm knurled nut $M_D = 9,5$ Nm HB0 $M_D = 5,5$ Nm HB4,5

**Attention!** For stack assembly please observe the remarks in the operating instructions

## SURFACE TREATMENT

- ◆ The cartridge body, the slip-on coil and the armature tube are zinc-nickel coated

## COMMISSIONING

**Attention!** The solenoid coil must only be put into operation, if the requirements of the operating instructions supplied are observed to their full extent. In case of non-observance, no liability can be assumed.

**Wandfluh AG** Postfach CH-3714 Frutigen  
 Tel. +41 33 672 72 72 Fax +41 33 672 72 12 sales@wandfluh.com