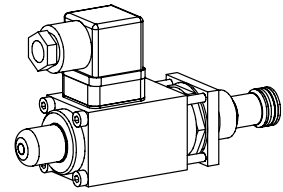

Proportional inverse pressure relief valve
Screw-in cartridge

- Direct operated
- $Q_{max} = 20 \text{ l/min}$
- $p_{max} = 400 \text{ bar}$
- $p_{Nmax} = 315 \text{ bar}$

M22x1,5
 ISO 7789

DESCRIPTION

Direct operated proportional pressure relief valve with inverse function. Thread M22x1,5 for cavity according to ISO 7789. As standard versions, 7 pressure ranges are available: 20, 40, 63, 100, 160, 200, 315 bar. Good flow performance due to the differential area principle. Small leak along the poppet guide. Adjustmend by a Wandfluh proportional solenoid. The cartridge and the solenoid made of steel are zinc coated and therefore rust-protected. Wandfluh proportional amplifiers are needed to control the proportional pressure relief valve (register 1.13).

FUNCTION

The valve limits the pressure in the port P (1) and reliefs the volume flow to tank port T (2). The back pressure in T (2) influences the pressure in P (1). A spring, which is adjustable from the outside within a limited range, presses the poppet against the seat and hereby adjusts the maximum operating pressure. The force of the proportional solenoid counteracts the spring force. For this reason, the operating pressure declines with the increasing solenoid current (inverse function). When the solenoid is currentless, the maximum operating pressure is present. The pressure on the guided poppet acts on a differential area between the seat diameter and poppet guide diameter. The good flow characteristics are achieved through large seat diameters.

APPLICATION

The valve has its application in hydraulic systems, in which the pressure frequently has to be changed. The facility for remote control and signal processing from process control systems enable elegant, comfortable solutions to problems. By means of the inverse function, the maximum system pressure is maintained if the electric valve control fails (safety function). In such cases, e.g., the descending of a load is prevented, or cooling ventilators with hydraulic motor drives are kept in operation. Installation of the screw-in cartridge in control blocks as well as in the Wandfluh sandwich plates (vertical stacked systems) and flange valves of the NG4-Mini and NG6 types. (Please note the separate data sheets in register 2.3).

CONTENT

GENERAL SPECIFICATIONS.....	1
HYDRAULIC SPECIFICATIONS.....	1
ELECTRICAL SPECIFICATIONS.....	1
SYMBOL.....	1
CHARACTERISTICS.....	2
DIMENSIONS/ SECTIONAL DRAWINGS.....	2
PARTS LIST.....	2
ACCESSORIES.....	2

TYPE CODE

Pressure relief valve	B	D	I	PM22	-		-		#	
Direct operated										
Proportional inverse										
Screw-in cartridge M22x1,5										
Standard nominal pressure ranges	$p_N = 20 \text{ bar}$	<input type="text" value="20"/>	$p_N = 160 \text{ bar}$	<input type="text" value="160"/>	$p_N = 40 \text{ bar}$	<input type="text" value="40"/>	$p_N = 200 \text{ bar}$	<input type="text" value="200"/>	$p_N = 63 \text{ bar}$	<input type="text" value="63"/>
	$p_N = 100 \text{ bar}$	<input type="text" value="100"/>	$p_N = 315 \text{ bar}$	<input type="text" value="315"/>						
Standard nominal voltage:	$U_N = 12 \text{ VDC}$	<input type="text" value="G12"/>	$U_N = 24 \text{ VDC}$	<input type="text" value="G24"/>						

Design-Index (Subject to change)

• Data sheet is valid from design-index #2 on

GENERAL SPECIFICATIONS

Description	Direct operated proportional pressure relief valve with inverse function
Construction	Screw-in cartridge for cavity to ISO 7789
Operations	Proportional solenoid with spring
Mounting	Screw-in thread M22x1,5
Ambient temperature	-20...+50 °C
Mounting position	any
Fastening torque	$M_D = 50 \text{ Nm}$ for screw-in cartridge $M_D = 2,6 \text{ Nm}$ (qual. 8.8) for solenoid screws
Weight	$m = 0,6 \text{ kg}$

HYDRAULIC SPECIFICATIONS

Fluid	Mineral oil, other fluid on request
Contamination efficiency	ISO 4406:1999, class 18/16/13 (Required filtration grade $\beta_{6...10} \geq 75$) see data sheet 1.0-50/2
Viscosity range	12 mm ² /s...320 mm ² /s
Fluid temperature	-20...+70 °C
Peak pressure	$p_{max} = 400 \text{ bar}$
Nominal pres. ranges	see type code
Min. volume flow	$Q_{min} = 0,2 \text{ l/min}$
Max. volume flow	$Q_{max} = 20 \text{ l/min}$ for $p_N = 20/40/100/160/200 \text{ bar}$ $Q_{max} = 15 \text{ l/min}$ for $p_N = 63/315 \text{ bar}$
Leakage volume flow	see characteristics
Repeatability	$\leq 2 \% *$
Hysteresis	$\leq 4 \% *$
	* at optimal dither signal

ELECTRICAL SPECIFICATIONS

Construction	Proportional solenoid, wet pin push type, pressure tight	
Standard-nominal voltage	$U_N = 12 \text{ VDC}$	$U_N = 24 \text{ VDC}$
Limiting current	$I_G = 1250 \text{ mA}$	$I_G = 680 \text{ mA}$
Relative duty factor	100% DF (see data sheet 1.1-430)	
Protection class	IP 65 acc. to EN 60 529	
Connection/Power supply	Over device plug connection to ISO 4400 / DIN 43 650 (2P+E)	
Other electrical specifications	see data sheet 1.1-117	

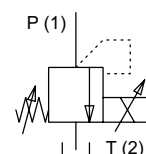
SYMBOL

CHARACTERISTICS oil viscosity $\nu = 30 \text{ mm}^2/\text{s}$

$p = f(Q)$ Pressure volume flow characteristics
(Maximum adjustable pressure)

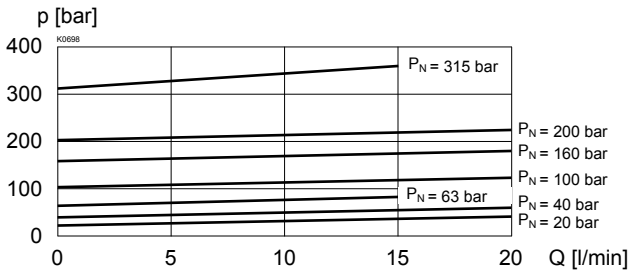

$p = f(I)$ Pressure adjustment characteristics
($Q = 1 \text{ l/min}$)

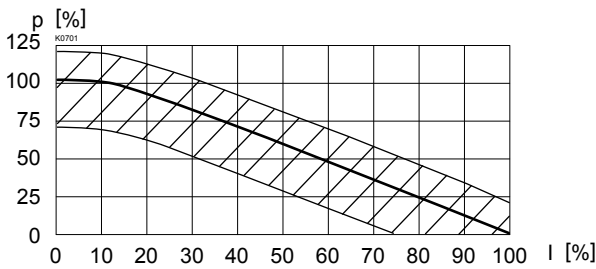

Adjustable range of nominal pressure, adjusted with set screw under the clamp cap.

$p = f(Q)$ Pressure volume flow characteristics
(Minimum adjustable pressure)

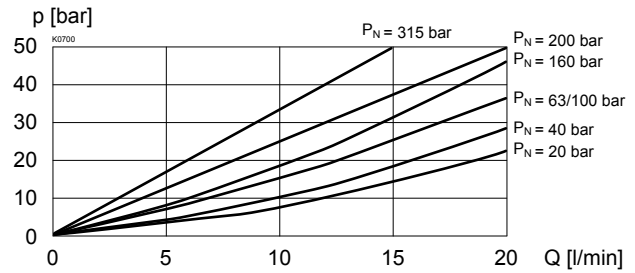

$Q_L = f(p)$ Leakage volume flow characteristics

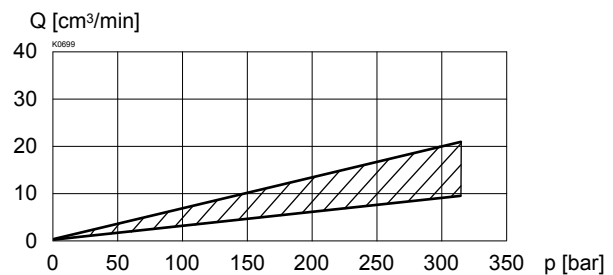

DIMENSIONS / SECTIONAL DRAWINGS

Adjustment screw to set the nominal pressure (+20 % / -30 %)

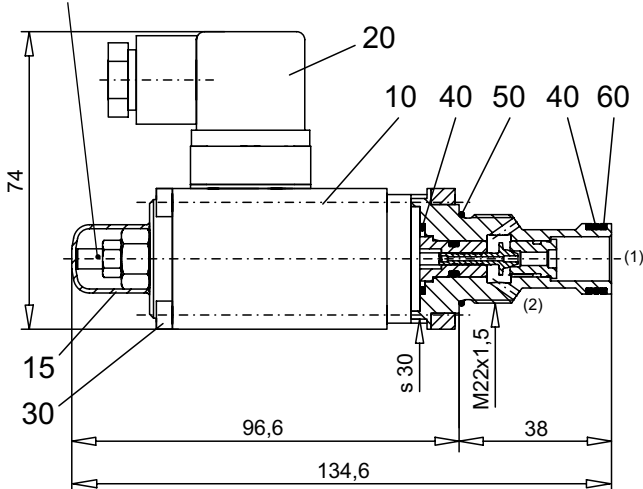

Cavity drawing according to
ISO 7789-22-02-0-98

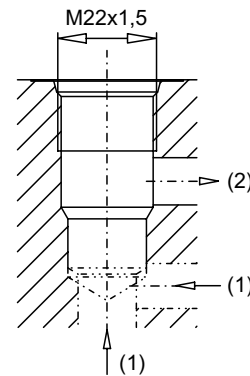

For detailed cavity drawing and cavity tools see data sheet 2.13-1003

PARTS LIST

Position	Article	Description
10	256.3497 256. ...	Proportional solenoid PI35V-G24-M152 Proportional solenoid PI35V-G12-M152
15	253.8012 123.9030	Manual override HB4,5-H44 Clamp cap
20	219.2002	Plug (black)
30	246.1171	Socket head cap screw M4x70 DIN 912
40	160.2140	O-ring ID 14,00x1,78
50	160.2188	O-ring ID 18,77x1,78
60	049.3177	Back-up ring RD 14,6x17,5x1,4

ACCESSORIES

Cartridge built-in flange- or sandwich body
Flange-/sandwich plate
Proportional amplifier

Register 2.3
Register 1.13

Technical explanation see data sheet 1.0-100