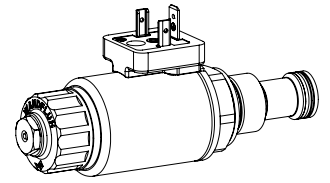

Proportional pressure relief cartridge

- ◆ direct operated
- ◆ $Q_{max} = 25 \text{ l/min}$
- ◆ $p_{max} = 400 \text{ bar}$
- ◆ $p_{Nmax} = 350 \text{ bar}$

M22 x 1,5
ISO 7789

DESCRIPTION

Direct operated proportional pressure relief valve in screw-in cartridge construction for cavity according to ISO 7789. Good flow capacity due to the differential area principle, very sensitively adjustable. When the operating pressure adjusted by means of the proportional solenoid is reached, the valve opens and connects the protected line with the drain to the tank. The back pressure in T (2) affects the pressure in P (1). For the control, Wandfluh proportional amplifiers are available (see register 1.13).

APPLICATION

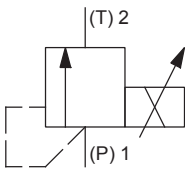
The electrical remote control in conjunction with process controls allows economical solutions with repeatable processes. The screw-in cartridge is perfectly suitable for installation in control blocks and is installed in sandwich- (vertical stacked systems) and in flange plates (corresponding data sheets in this register). For machining the cartridge cavity in steel and aluminum blocks, cavity tools are available (hire or purchase). Please refer to the data sheets in register 2.13.

SYMBOL

ACTUATION

Actuation	Proportional solenoid, wet pin push type, pressure tight
Execution	W.S37 / 19 x 50 (Data sheet 1.1-173) M.S35 / 19 x 50 (Data sheet 1.1-174)
Connection	Connector socket EN 175301 – 803 Connector socket AMP Junior-Timer Connector Deutsch DT04 – 2P

TYPE CODE

		B D P PM22 -		<input type="text"/>	-	<input type="text"/>	/	<input type="text"/>	<input type="text"/>	-	<input type="text"/>	#	<input type="text"/>
Pressure relief valve													
Direct operated													
Proportional													
Screw-in cartridge M22 x 1,5													
Nominal pressure range p_N	20 bar	<input type="text" value="20"/>	315 bar	<input type="text" value="315"/>									
	100 bar	<input type="text" value="100"/>	350 bar	<input type="text" value="350"/>									
	200 bar	<input type="text" value="200"/>											
Nominal voltage U_N	12 VDC	<input type="text" value="G12"/>											
	24 VDC	<input type="text" value="G24"/>											
	without coil	<input type="text" value="X5"/>											
Slip-on coil	Metal housing round	<input type="text" value="W"/>											
	Metal housing square	<input type="text" value="M"/>											
Connection execution	Connector socket EN 175301-803 / ISO 4400	<input type="text" value="D"/>											
	Connector socket AMP Junior - Timer	<input type="text" value="J"/>											
	Connector Deutsch DT04 - 2P	<input type="text" value="G"/>											
Sealing material	NBR	<input type="text"/>											
	FKM (Viton)	<input type="text" value="D1"/>											
Manual override	Manual override	<input type="text" value="HB4,5"/>											
	Screw plug	<input type="text" value="HB0"/>											
Design index (subject to change)													

2.3-529

GENERAL SPECIFICATIONS

Designation	Proportional pressure relief valve
Construction	Direct operated
Mounting	Screw-in cartridge construction
Nominal size	M22 x 1,5 according to ISO 7789
Actuation	Proportional solenoid
Ambient temperature	-25...+70 °C
Weight	0,6 kg
MTTFd	150 years

ELECTRICAL SPECIFICATIONS

Protection class	Connection execution D: IP65 Connection execution J: IP66 Connection execution G: IP67 and IP69K
Relative duty factor	100 % DF
Standard nominal voltage	12 VDC, 24 VDC
Limiting current at 50 °C	$I_G = 1320 \text{ mA}$ ($U_N = 12\text{VDC}$) $I_G = 660 \text{ mA}$ ($U_N = 24\text{VDC}$)

Note! Other electrical specifications see data sheet 1.1-173 (slip-on coil W) and 1.1-174 (slip-on coil M)

HYDRAULIC SPECIFICATIONS

Working pressure	$p_{\max} = 400 \text{ bar}$
Nominal pressure range	$P_N = 20 \text{ bar}, 100 \text{ bar}, 200 \text{ bar}, 315 \text{ bar}, 350 \text{ bar}$
Maximum volume flow	$Q_{\max} = 25 \text{ l/min}$ ($p_N = 20 / 100 / 200 \text{ bar}$) $Q_{\max} = 20 \text{ l/min}$ ($p_N = 315 \text{ bar}$) $Q_{\max} = 2 \text{ l/min}$ ($p_N = 350 \text{ bar}$)
Minimum volume flow	$Q_{\min} = 0,1 \text{ l/min}$
Leakage oil	See characteristics
Hysteresis	$\leq 4 \%$ at optimal dither signal
Repeatability	$\leq 1 \%$ at optimal dither signal
Fluid	Mineral oil, other fluid on request
Viscosity range	12 mm ² /s...320 mm ² /s
Temperature range fluid	-25...+70 °C (NBR) -20...+70 °C (FKM)
Contamination efficiency	Class 18 / 16 / 13
Filtration	Required filtration grade $\beta_{6...10} \geq 75$, see data sheet 1.0-50

PERFORMANCE SPECIFICATIONS

Oil viscosity $\nu = 30 \text{ mm}^2/\text{s}$

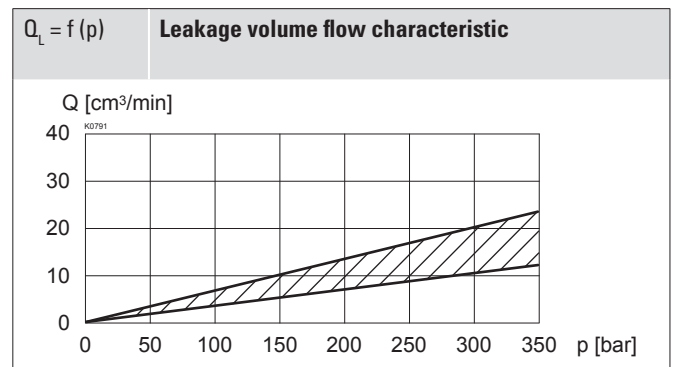
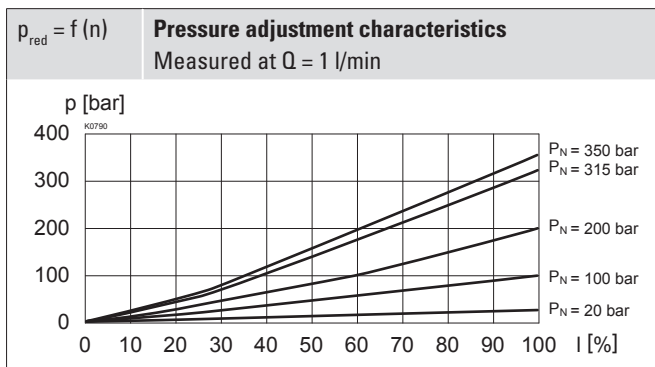
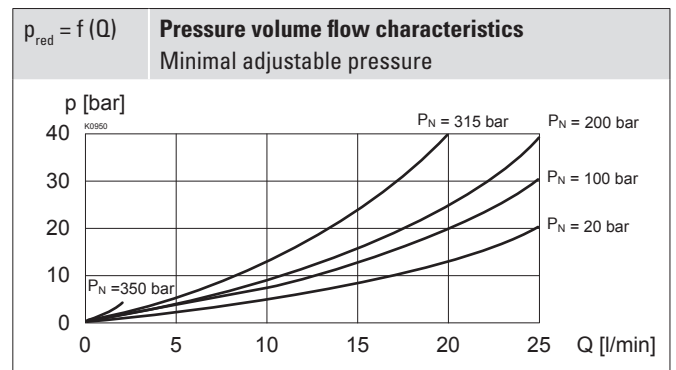
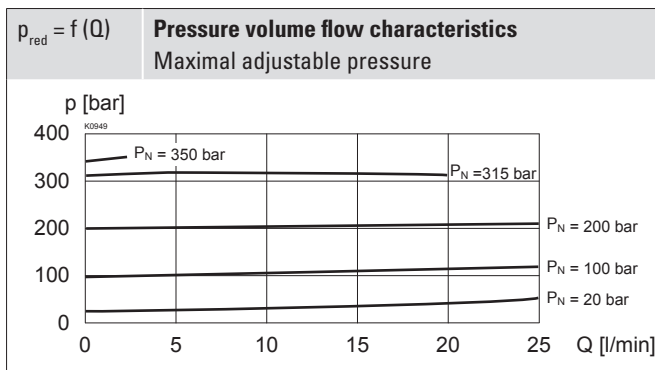

DIMENSIONS

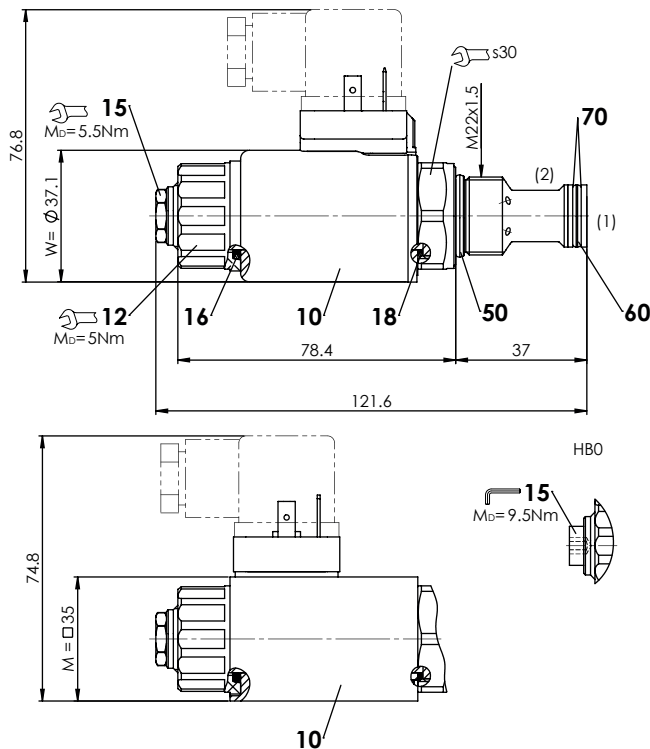

HYDRAULIC CONNECTION

Cavity drawing according to ISO 7789-22-02-0-98

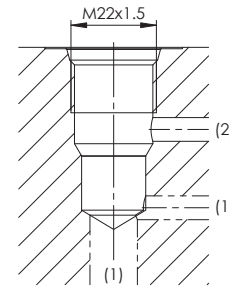

Note!



For detailed cavity drawing and cavity tools see data sheet 2.13-1003

MANUAL OVERRIDE

HB4,5

Optionally: Screw plug (HB0), no actuation possible

SURFACE TREATMENT

- ◆ The cartridge body made of steel and the slip-on coil are zinc-nickel coated

PARTS LIST

Position	Article	Description
10	206.2...	W.S37 / 19 x 50
	260.5...	M.S35 / 19 x 50
12	154.2700	Knurled nut
15	253.8000	HB4,5 manual override
	239.2033	HB0 Screw plug
	251.5917	Seal kit
	251.5918	Seal kit D1

Seal kit consisting of:

16	O-ring	ID 18,72 x 2,62
18	O-ring	ID 17,17 x 1,78
50	O-ring	ID 18,77 x 1,78
60	O-ring	ID 14,00 x 1,78
70	B.up ring	PTFE rd 14,6 x 17,5 x 1,4

STANDARDS

Cartridge cavity	ISO 7789
Solenoids	DIN VDE 0580
Connection execution D	EN 175301 – 803
Protection class	EN 60 529
Contamination efficiency	ISO 4406

ACCESSORIES

Proportional amplifier	Register 1.13
Electric plug B (black)	Article no. 219.2002
Flange body / sandwich plate NG4-Mini	Data sheet 2.3-720
Flange body / sandwich plate NG6	Data sheet 2.3-740
Flange body / sandwich plate NG10	Data sheet 2.3-760
Threaded body	Data sheet 2.9-200
Technical explanations	Data sheet 1.0-100
Filtration	Data sheet 1.0-50

SEALING MATERIAL

NBR or FKM (Viton) as standard, choice in the type code

INSTALLATION NOTES

Mounting type	Screw-in cartridge M22 x 1,5
Mounting position	Any, preferably horizontal
Tightening torque	$M_D = 60 \text{ Nm}$ Screw-in cartridge $M_D = 5 \text{ Nm}$ knurled nut $M_D = 9,5 \text{ Nm}$ HB0 $M_D = 5,5 \text{ Nm}$ HB4,5

Wandfluh AG Postfach CH-3714 Frutigen
 Tel. +41 33 672 72 72 Fax +41 33 672 72 12 sales@wandfluh.com