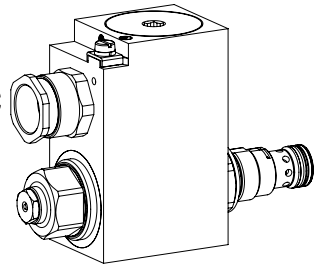

Proportional pressure relief cartridge

- ◆ pilot operated
- ◆ $Q_{max} = 100 \text{ l/min}$
- ◆ $p_{max} = 400 \text{ bar}$
- ◆ $p_{Nmax} = 350 \text{ bar}$

M22 x 1,5
ISO 7789

- ⊕ II 2 G Ex db IIC T6, T4
- ⊕ II 2 D Ex tb III C T80 °C, T130 °C
- ⊕ I M2 Ex db I Mb
- Class I Division 1
- Class I Zone 1

DESCRIPTION

Pilot operated proportional pressure relief valve in screw-in cartridge construction for cavity according to ISO 7789. High flow capacity, very sensitively adjustable. When the operating pressure adjusted by means of the proportional solenoid is reached, the valve opens and connects the protected line with the drain to the tank. The back pressure in T (2) affects the pressure in P (1). For the control, Wandfluh proportional amplifiers are available (see register 1.13). The pressure tight encapsulated Ex-protection solenoid coil prevents an explosion on the inside penetrating to the outside as well as an ignitable surface temperature.

APPLICATION

These valves are suitable for applications in explosion-hazard areas, open cast and also in mines. The electrical remote control in conjunction with process controls allows economical solutions with repeatable processes. The screw-in cartridge is perfectly suitable for installation in control blocks and is installed in sandwich- (vertical stacked systems) and in flange plates (corresponding data sheets in this register). For machining the cartridge cavity in steel and aluminum blocks, cavity tools are available (hire or purchase). Please refer to the data sheets in register 2.13.

TYPE CODE

| | | B V B PM22 - <input type="text"/> - <input type="text"/> / <input type="text"/> / <input type="text"/> - <input type="text"/> <input type="text"/> # <input type="text"/> | | | |
|--|---------------------------------|---|-----------------------------------|----------------------------------|----------------------------------|
| Pressure relief valve | | | | | |
| Pilot operated | | | | | |
| Proportional, explosion proof execution Ex d | | | | | |
| Screw-in cartridge M22 x 1,5 | | | | | |
| Execution | L9 | | L15 / L17 | | |
| Nominal pressure range p_N [bar] | <input type="text" value="20"/> | <input type="text" value="160"/> | <input type="text" value="20"/> | <input type="text" value="200"/> | <input type="text" value="350"/> |
| | <input type="text" value="50"/> | <input type="text" value="220"/> | <input type="text" value="63"/> | <input type="text" value="275"/> | <input type="text" value="350"/> |
| | <input type="text" value="80"/> | <input type="text" value="280"/> | <input type="text" value="100"/> | <input type="text" value="350"/> | <input type="text" value="350"/> |
| Nominal voltage U_N | 12 VDC | <input type="text" value="G12"/> | | | |
| | 24 VDC | <input type="text" value="G24"/> | | | |
| Nominal power P_N | 9 W | <input type="text" value="L9"/> | <i>Ambient temperature up to:</i> | | |
| | 15 W | <input type="text" value="L15"/> | 40 °C or 90 °C | | |
| | 17 W | <input type="text" value="L17"/> | 70 °C | | |
| | | | 70 °C (only UL / CSA) | | |
| Certification | ATEX, IECEx, EAC, CCC | <input type="text"/> | UL / CSA | <input type="text" value="UL"/> | <input type="text"/> |
| | Australia | <input type="text" value="AU"/> | MA | <input type="text" value="MA"/> | <input type="text"/> |
| Sealing material | NBR | <input type="text"/> | | | |
| | FKM (Viton) | <input type="text" value="D1"/> | | | |
| Options | without amplifier | <input type="text"/> | | | |
| | | <input type="text" value="M248"/> | | | |
| Design index (subject to change) | | | | | |

2.3-536

CERTIFICATES

| | Surface | Mining | Standard -25 °C to... | M248 Electronic |
|-----------|---------|--------|-----------------------------|--------------------|
| ATEX | x | x | x | x |
| IECEx | x | x | x | x |
| CCC | x | x | x | x |
| EAC | x | x | x | x |
| Australia | x | x | x | |
| MA | | x | x | x |
| UL / CSA | x | | x | |

The certificates can be found on www.wandfluh.com

GENERAL SPECIFICATIONS

| | |
|---------------------|--|
| Designation | Proportional pressure relief valve |
| Construction | Pilot operated |
| Mounting | Screw-in cartridge construction |
| Nominal size | M22 x 1,5 according to ISO 7789 |
| Actuation | Proportional solenoid |
| Ambient temperature | Operation as T6 -25...+40 °C (L9) Operation as T4 -25...+90 °C (L9) -25...+70 °C (L15 / L17) |
| Weight | 1,9 kg |
| MTTFd | 150 years |

ELECTRICAL SPECIFICATIONS

| | |
|---------------------------|--|
| Protection class | IP65 / 66 / 67 |
| Relative duty factor | 100 % DF |
| Voltage tolerance | ± 10 % with regard to nominal voltage |
| Standard nominal voltage | 12 VDC, 24 VDC |
| Limiting current at... °C | L9, 40 °C $I_G = 625 \text{ mA (12 VDC)}$ $I_G = 305 \text{ mA (24 VDC)}$ L15 / 17, 50 °C $I_G = 950 \text{ mA (12 VDC)}$ $I_G = 450 \text{ mA (24 VDC)}$ L15 / 17, 70 °C $I_G = 910 \text{ mA (12 VDC)}$ $I_G = 420 \text{ mA (24 VDC)}$ |
| Standard nominal power | 9 W, 15 W, 17 W |
| Temperature class | Nominal power 9 W: T1...T6 Nominal power 15 W / 17 W: T1...T4 |

Note! Other electrical specifications see data sheet 1.1-183 and 1.1-184

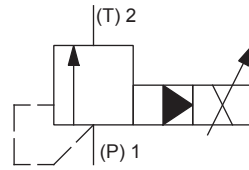
SYMBOL

HYDRAULIC SPECIFICATIONS

| | |
|--------------------------|---|
| Working pressure | $p_{max} = 400 \text{ bar}$ |
| Nominal pressure range | Execution L9 $P_N = 20 \text{ bar, 50 bar, 80 bar, 160 bar, 220 bar, 280 bar}$ Execution L15 / 17 $P_N = 20 \text{ bar, 63 bar, 100 bar, 200 bar, 275 bar, 350 bar}$ |
| Volume flow range | $Q = 0,3...100 \text{ l/min}$ |
| Leakage oil | See characteristics |
| Hysteresis | ≤ 5 % at optimal dither signal |
| Repeatability | ≤ 2 % at optimal dither signal |
| Fluid | Mineral oil, other fluid on request |
| Viscosity range | $12 \text{ mm}^2/\text{s}...320 \text{ mm}^2/\text{s}$ |
| Temperature range fluid | Operation as T6 NBR -25...+40 °C (L9) FKM -20...+40 °C (L9) Operation as T4 NBR -25...+70 °C (L9 or L15 / L17) FKM -20...+70 °C (L15 / L17) FKM -20...+70 °C (L9) |
| Contamination efficiency | Class 18 / 16 / 13 |
| Filtration | Required filtration grade $\beta_{6...10} \geq 75$, see data sheet 1.0-50 |

ACTUATION

| | |
|------------|--|
| Actuation | Proportional solenoid, wet pin push type, pressure tight |
| Execution | MKY45 / 18x60 (data sheet 1.1-183) MKU45 / 18x60 (data sheet 1.1-184) |
| Connection | Cable gland for cable $\varnothing 6,5...14 \text{ mm}$ |

Attention! The UL execution is always supplied without cable gland

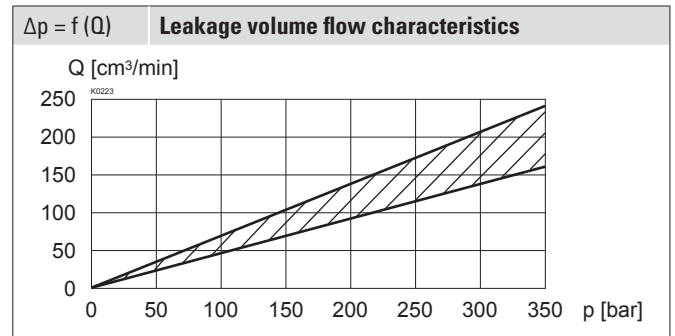
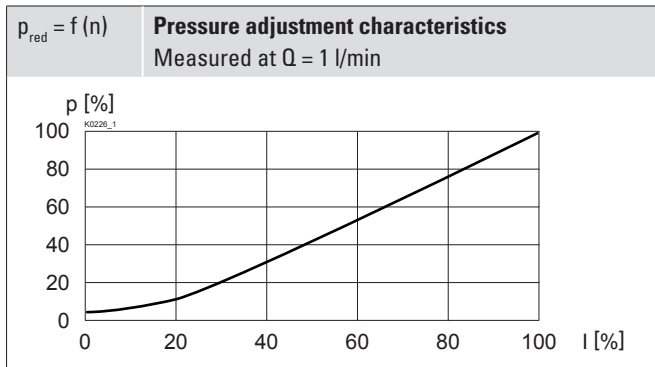
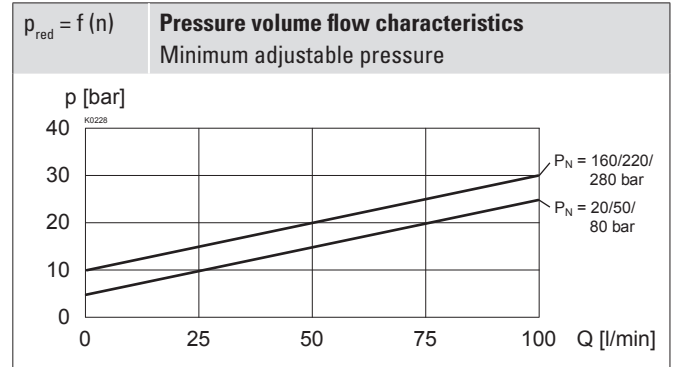
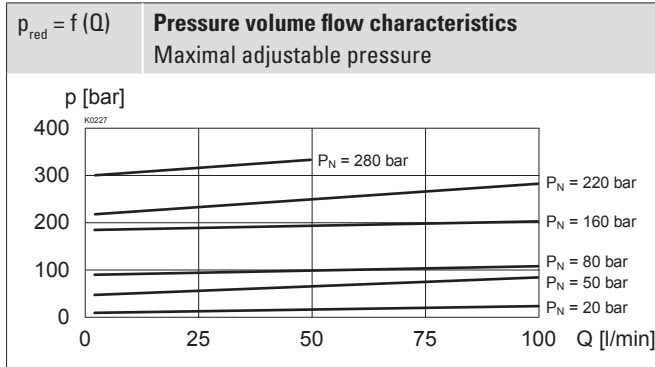

PERFORMANCE SPECIFICATIONS EXECUTION L9 (MEASURED AT 40 °C)

 Oil viscosity $\nu = 30 \text{ mm}^2/\text{s}$

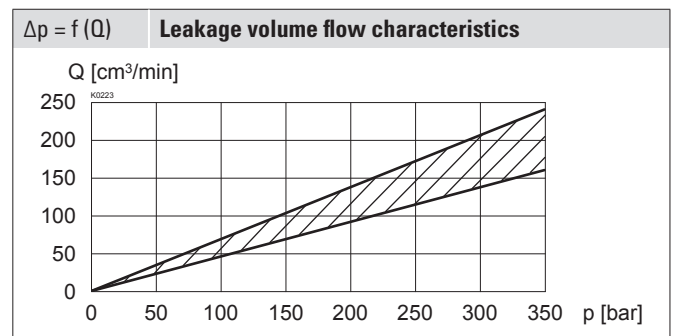
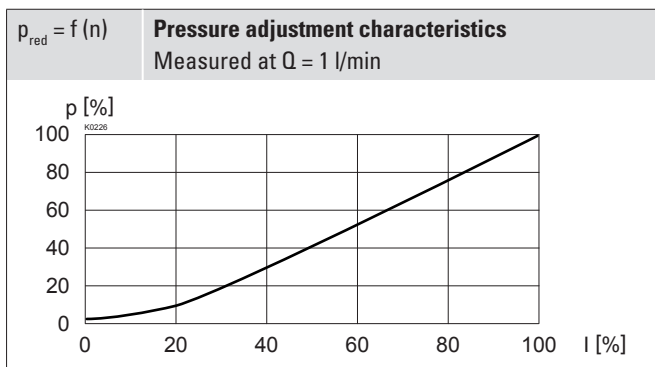
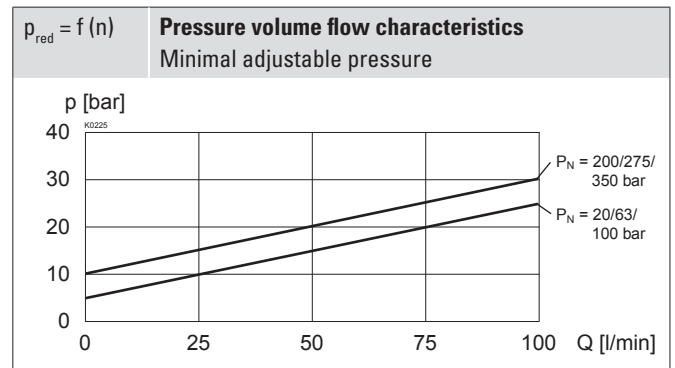
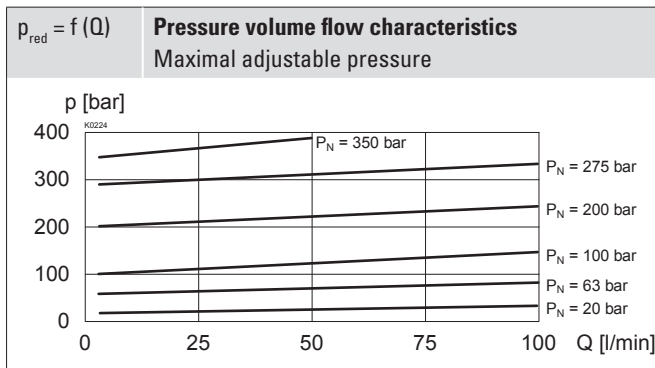
PERFORMANCE SPECIFICATIONS EXECUTION L15 / L17 (MEASURED AT 50 °C)

 Oil viscosity $\nu = 30 \text{ mm}^2/\text{s}$

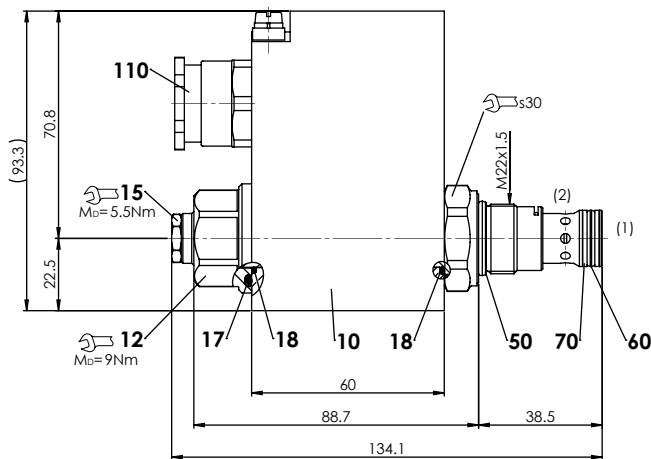
DIMENSIONS



Dimensions of the solenoid coil see data sheet 1.1-183 and 1.1-184

PARTS LIST

| Position | Article | Description |
|----------|----------|-----------------------------------|
| 10 | 263.6... | Solenoid coil MK.45 / 18 x 60 |
| 12 | 154.2603 | Knurled nut Ex M18 x 1,5 x 18 |
| 15 | 253.8000 | Manual override HB4,5 |
| 17 | 160.2251 | O-ring ID 25,07 x 2,62 (NBR) |
| 18 | 160.2170 | O-ring ID 17,17 x 1,78 (NBR) |
| 50 | 160.2188 | O-ring ID 18,77 x 1,78 (NBR) |
| | 160.8188 | O-ring ID 18,77 x 1,78 (FKM) |
| 60 | 160.2140 | O-ring ID 14,00 x 1,78 (NBR) |
| | 160.8140 | O-ring ID 14,00 x 1,78 (FKM) |
| 70 | 049.3177 | Back-up ring rd 14,6 x 17,5 x 1,4 |
| 110 | 111.1080 | Cable gland M20 x 1,5 |

STANDARDS

| | |
|--------------------------|---------------------------------|
| Cartridge cavity | ISO 7789 |
| Explosion protection | Directive 2014 / 34 / EU (ATEX) |
| Flameproof enclosure | EN / IEC / UL 60079-1, 31 |
| Cable entry | EN 60079-0, 1, 7, 15, 31 |
| Protection class | EN 60 529 |
| Contamination efficiency | ISO 4406 |

INSTALLATION NOTES

| | |
|-------------------|--|
| Mounting type | Screw-in cartridge M22 x 1,5 |
| Mounting position | Any, preferably horizontal |
| Tightening torque | $M_D = 60$ Nm Screw-in cartridge $M_D = 9$ Nm knurled nut $M_D = 9,5$ Nm HB0 $M_D = 5,5$ Nm HB4,5 |

Attention! For stack assembly please observe the remarks in the operating instructions



HYDRAULIC CONNECTION

Cavity drawing according to ISO 7789-22-02-0-98

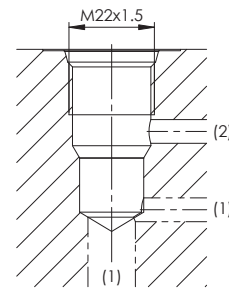

Note!



For detailed cavity drawing and cavity tools see data sheet 2.13-1003

ACCESSORIES

| | |
|---------------------------------------|--------------------|
| Proportional amplifier | Register 1.13 |
| Flange body / sandwich plate NG4-Mini | Data sheet 2.3-720 |
| Flange body / sandwich plate NG6 | Data sheet 2.3-740 |
| Flange body / sandwich plate NG10 | Data sheet 2.3-760 |
| Threaded body | Data sheet 2.9-200 |
| Technical explanations | Data sheet 1.0-100 |
| Filtration | Data sheet 1.0-50 |

MANUAL OVERRIDE

HB4,5 as standard

SEALING MATERIAL

NBR or FKM (Viton) as standard, choice in the type code

SURFACE TREATMENT

- ◆ The cartridge body, the slip-on coil and the armature tube are zinc-nickel coated

COMMISSIONING

Attention! The solenoid coil must only be put into operation, if the requirements of the operating instructions supplied are observed to their full extent. In case of non-observance, no liability can be assumed.



Wandfluh AG Postfach CH-3714 Frutigen
 Tel. +41 33 672 72 72 Fax +41 33 672 72 12 sales@wandfluh.com