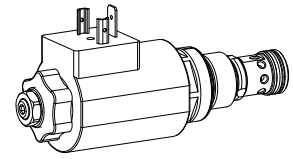

Proportional inverse pressure relief valve
Screw-in cartridge

- Pilot operated
- Nominal pressure adjustable +20 % / -30 %
- $Q_{max} = 100 \text{ l/min}$
- $p_{max} = 400 \text{ bar}$
- $p_{Nmax} = 200 \text{ bar}$

M22x1,5
 ISO 7789

DESCRIPTION

Pilot operated proportional pressure relief valve with inverse function. Thread M22x1,5 and cavity according to ISO 7789. As standard versions, 4 pressure levels are available. The adjustment takes place by means of a Wandfluh proportional solenoid (VDE-standard 0580). The cartridge body made of steel is zinc coated and therefore rust-protected. The solenoid coil is made of plastic.

FUNCTION

When the operating pressure set by the proportional solenoid is reached, the main spool opens and connects the protected line with the return line to the tank. The back pressure in T (2) influences the pressure in P (1). This pilot operated proportional pressure relief valve can be adjusted very sensitively and is suitable for large volume flows and high pressures. To control the valve, Wandfluh proportional amplifiers are available (see register 1.13).

APPLICATION

The valve has its application in hydraulic systems, in which the pressure frequently has to be changed. The facility for electric remote controlling of the valve in conjunction with process control systems enables economic problem solutions with repeatable sequences. Installation of the screw-in cartridge in control blocks. Cavity tools are available for machining the cavities in steel and aluminium (hire or purchase). Please refer to the data sheets in register 2.13.

TYPE CODE

Pressure relief valve	B N I PM22 - <input type="text"/> - <input type="text"/> / K <input type="text"/> - <input type="text"/> # <input type="text"/>	
Pilot operated, inverse		
Proportional		
Screw-in cartridge M22x1,5		
Nominal pressure range p_N	63 bar <input type="text" value="63"/>	
	100 bar <input type="text" value="100"/>	
	160 bar <input type="text" value="160"/>	
	200 bar <input type="text" value="200"/>	
Nominal voltage U_N	12 VDC <input type="text" value="G12"/>	
	24 VDC <input type="text" value="G24"/>	
	without coil <input type="text" value="X5"/>	
Slip-on coil	Plastic housing round	
Connection execution	Connector socket EN 175301-803 / ISO 4400 <input type="text" value="D"/>	
	Connector socket AMP Junior-Timer <input type="text" value="J"/>	
	Connector Deutsch DT04-2P <input type="text" value="G"/>	(only for G24)
Sealing material	NBR <input type="text"/>	
	FKM (Viton) <input type="text" value="D1"/>	
Design-Index (Subject to change)		

GENERAL SPECIFICATIONS

Description	Pilot operated proportional pressure relief valve with inverse function
Construction	Screw-in cartridge for cavity to ISO 7789
Actuation	Proportional solenoid
Mounting	Screw-in thread M22x1,5
Ambient temperature	-20...+50 °C
Mounting position	any, preferably horizontal
Fastening torque	$M_D = 50 \text{ Nm}$ for screw-in cartridge $M_D = 3 \pm 1,2 \text{ Nm}$ for knurled nut $M_D = 9,5 \text{ Nm}$ for hexagon nut
Weight	$m = 0,45 \text{ kg}$

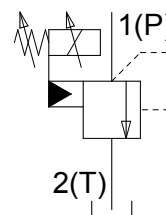
SYMBOLS

ELECTRICAL SPECIFICATIONS



Construction	Proportional solenoid, wet pin push type, pressure tight	
Standard-Nominal voltage	$U_N = 12$ VDC	$U_N = 24$ VDC
	$I_G = 1250$ mA	$I_G = 680$ mA
Limiting current		
Relative duty factor	100% DF (see data sheet 1.1-430)	
Protection class acc. EN 60529	Connection version D: IP 65 J: IP 66 G: IP 67 / IP69K acc. EN 40050	

For further electrical specifications see data sheet 1.1-172

HYDRAULIC SPECIFICATIONS

Fluid	Mineral oil, other fluid on request
Contamination efficiency	ISO 4406:1999, class 18/16/13 (Required filtration grade $\beta_{6...10} \geq 75$) see data sheet 1.0-50/2
Viscosity range	12 mm ² /s...320 mm ² /s
Fluid temperature	-20...+70 °C
Peak pressure	$p_{max} = 400$ bar $p_{Tmax} = 50$ bar
Nominal pressure ranges	$p_N = 63, 100, 160, 200$ bar
Volume flow	$Q = 5...100$ l/min with $p_N = 63 / 100 / 160$ bar $Q = 10...100$ l/min with $p_N = 200$ bar
Leakage volume flow	see characteristics
Hysteresis	$\leq 5\%$ * * at optimal dither signal

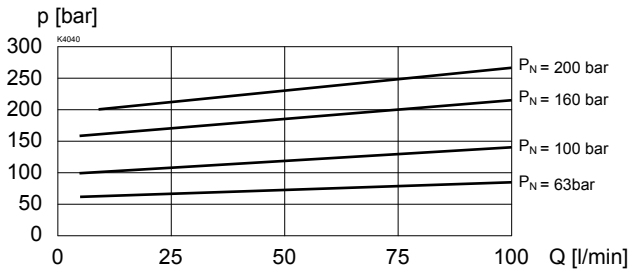
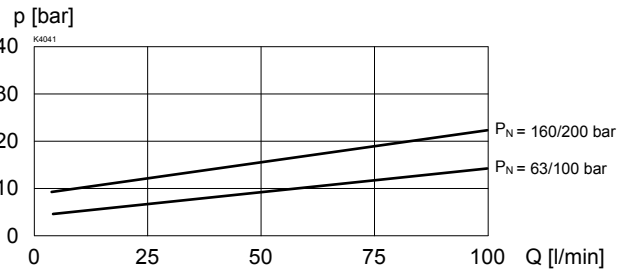
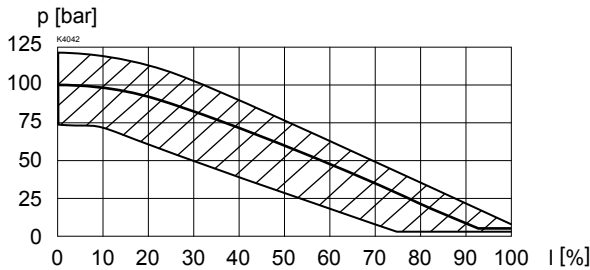
CHARACTERISTICS Oil viscosity $\nu = 30$ mm²/s

 $p = f(Q)$ Pressure volume flow characteristics
 (Maximum adjustable pressure)

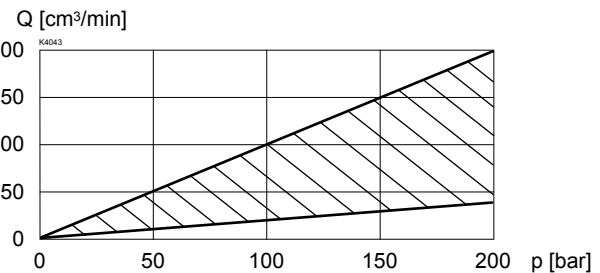
 $p = f(Q)$ Pressure volume flow characteristics
 (Minimum adjustable pressure)

 $p = f(I)$ Pressure adjustment characteristics
 ($Q = 5$ l/min)

 Adjustable range of nominal pressure, adjusted with set screw..

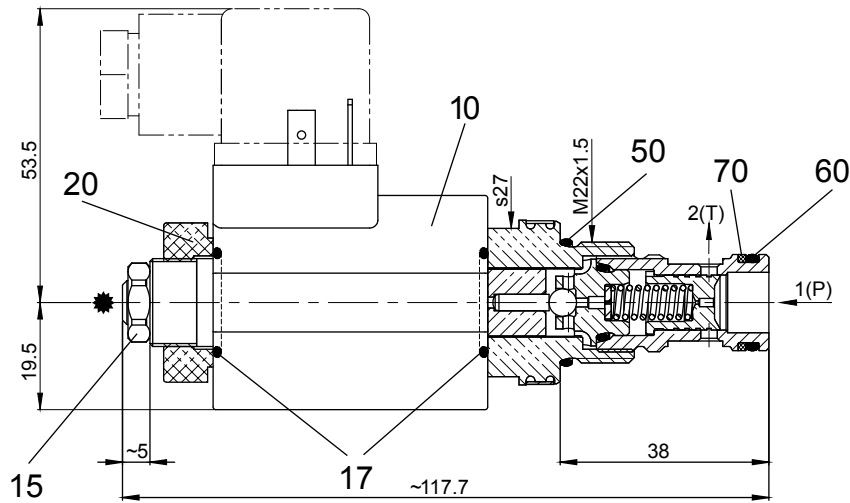
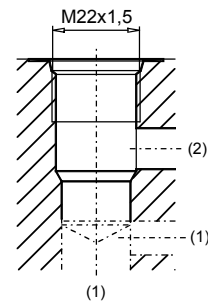
 $Q_L = f(p)$ Leakage volume flow characteristics

DIMENSIONS / SECTIONAL DRAWINGS

* Adjusting screw for setting the nominal pressure (+20 % / -30 %)

 Cavity drawing according to
 ISO 7789-22-02-0-98

 For detailed cavity drawing
 and cavity tools
 see data sheet 2.13-1003

Dimensions of the other connection versions see data sheet 1.1-172

Position	Article	Description
10	206.2301	EN 175301 solenoid coil KD35/16-G24
	206.2300	solenoid coil KD35/16-G12
	206.2303	Junior-Timer solenoid coil KJ35/16-G24
	206.2302	solenoid coil KJ35/16-G12
206.2304	Deutsch solenoid coil KG35/16-G24	
	206.2304	solenoid coil KG35/16-G24
15	153.1402	Hexagon nut M8x1
17	160.1156	O-ring ID 15,60 x1,78 (NBR)
20	154.2600	Knurled nut
50	160.2188	O-ring ID 18,77 x 1,78 (NBR)
	160.6188	O-ring ID 18,77 x 1,78 (FKM)
60	160.2140	O-ring ID 14,00 x 1,78 (NBR)
	160.6141	O-ring ID 14,00 x 1,78 (FKM)
70	049.3177	Backup ring RD 14,6 x 17,5 x 1,4

ACCESSORIES

Flange-/sandwich plate NG4-Mini	Data sheet 2.3-720
Flange-/sandwich plate NG6	Data sheet 2.3-740
Flange-/sandwich plate NG10	Data sheet 2.3-760
Line mount body	Data sheet 2.9-200
Proportional amplifier	Register 1.13
Mating connector EN 175301-803	Article no. 219.2002

Technical explanation see data sheet 1.0-100