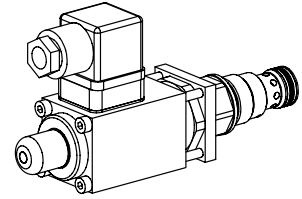

**Proportional inverse pressure relief valve  
Screw-in cartridge**

- Pilot operated
- $Q_{max} = 100$  l/min
- $p_{max} = 400$  bar
- $p_{Nmax} = 350$  bar

**M22x1,5**  
 ISO 7789

**DESCRIPTION**

Pilot operated proportional pressure relief valve with inverse function. Thread M22x1,5 and cavity according to ISO 7789. As standard versions, 7 pressure levels are available. The differential area between the seat diameter and the poppet guide diameter determines the pressure level. Flat pressure volume flow characteristic. The regulation is effected through a Wandfluh proportional solenoid. The cartridge body and the solenoid made of steel are zinc coated and thus rust-protected. Wandfluh proportional amplifiers are needed to control the proportional pressure relief valve (register 1.13).

**FUNCTION**

The valve relieves the pressure in connection P (1) and allows the inflowing volume flow to flow off to T (2). Back pressure in T influences the pressure in P. The pilot controls the spool of the main stage. When the pilot responds, a pilot volume flows. The thus resulting pressure differential on the spring-loaded control spool moves it from a closed position to an open control position. The pilot operates with a guided poppet as control element. A spring which is adjustable from the outside within a limited range presses the guided poppet against the seat and hereby adjusts the maximum operating pressure. The force of the proportional solenoid counteracts the spring force. For this reason, the operating pressure declines with an increasing solenoid current (inverse function). When the solenoid is currentless, the maximum operating pressure is present.

**APPLICATION**

The valve has its application in hydraulic systems, in which the pressure frequently has to be changed. The facility for remote control and signal processing from process control systems enable elegant, comfortable solutions to problems. By means of the inverse function, the maximum system pressure is maintained if the electric valve control fails (safety function). In such cases, e.g., the descending of a load is prevented, or cooling ventilators with hydraulic motor drives are kept in operation. Installation of the screw-in cartridge in control blocks as well as in the Wandfluh sandwich plates (vertical stacked systems) and flange valves of the NG4-Mini, NG6 and NG10 types. (Please note the separate data sheets in register 2.3).

**CONTENT**

GENERAL SPECIFICATIONS.....	1
HYDRAULIC SPECIFICATIONS.....	1
ELECTRICAL SPECIFICATIONS.....	1
SYMBOL.....	1
CHARACTERISTICS.....	2
DIMENSIONS/ SECTIONAL DRAWINGS.....	2
PARTS LIST.....	2
ACCESSORIES.....	2

**TYPE CODE**

Pressure relief valve	B	V	I	PM22	-		-		#	
Pilot operated										
Proportional inverse										
Screw-in cartridge M22x1,5										
Standard nominal pressure ranges:	$p_N = 20$ bar	<input type="text" value="20"/>	$p_N = 160$ bar	<input type="text" value="160"/>	$p_N = 40$ bar	<input type="text" value="40"/>	$p_N = 200$ bar	<input type="text" value="200"/>	$p_N = 63$ bar	<input type="text" value="63"/>
	$p_N = 100$ bar	<input type="text" value="100"/>	$p_N = 350$ bar	<input type="text" value="350"/>						
Standard nominal voltage:	$U_N = 12$ VDC	<input type="text" value="G12"/>	$U_N = 24$ VDC	<input type="text" value="G24"/>						

Design-Index (Subject to change)

- Data sheet is valid from design-index #2 on

**GENERAL SPECIFICATIONS**

Description	Pilot operated proportional pressure relief valve with inverse function
Construction	Screw-in cartridge for cavity to ISO 7789
Operations	Proportional solenoid with spring
Mounting	Screw-in thread M22x1,5
Ambient temperature	-20...+50 °C
Mounting position	any
Fastening torque	$M_D = 50$ Nm for screw-in cartridge $M_D = 2,6$ Nm (Qual. 8.8) for solenoid screws
Weight	$m = 0,6$ kg

**HYDRAULIC SPECIFICATIONS**

Fluid	Mineral oil, other fluid on request
Contamination efficiency	ISO 4406:1999, class 18/16/13 (Required filtration grade $\beta_{6...10} \geq 75$ ) see data sheet 1.0-50/2
Viscosity range	12 mm <sup>2</sup> /s...320 mm <sup>2</sup> /s
Fluid temperature	-20...+70 °C
Peak pressure	$p_{max} = 400$ bar $p_{Tmax} = p_p + 20$ bar
Nominal pressure ranges	see type code, others on request
Volume flow	$Q = 5...100$ l/min
Leakage volume flow	see characteristics
Repeatability	$\leq 3\%$ *
Hysteresis	$\leq 4\%$ *

\* at optimal dither signal

**ELECTRICAL SPECIFICATIONS**

Construction	Proportional solenoid, wet pin push type, pressure tight	
Standard-nominal voltage	$U_N = 12$ VDC	$U_N = 24$ VDC
Limiting current	$I_G = 1250$ mA	$I_G = 680$ mA
Relative duty factor	100% DF (see data sheet 1.1-430)	
Protection class	IP 65 acc. to EN 60 529	
Connection/Power supply	Over device plug connection to ISO 4400 / DIN 43 650 (2P+E)	
Other electrical specifications	see data sheet 1.1-117	

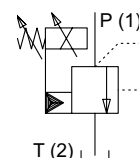
**SYMBOL**

**CHARACTERISTICS** oil viscosity  $\nu = 30 \text{ mm}^2/\text{s}$

$p = f(Q)$  Pressure volume flow characteristics  
(Maximal adjustable pressure)

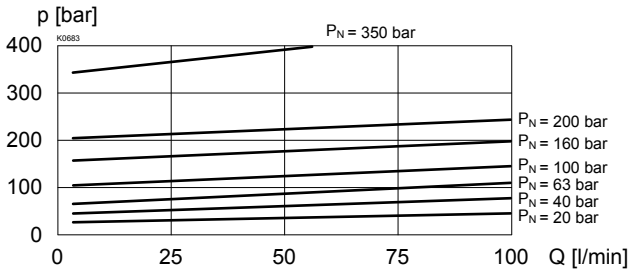

$p = f(Q)$  Pressure volume flow characteristics  
(Minimal adjustable pressure)

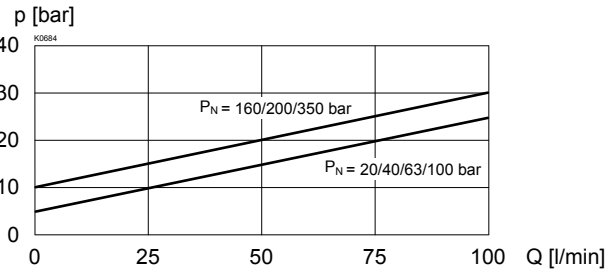

$p = f(I)$  Pressure adjustment characteristics  
( $Q = 5 \text{ l/min}$ )

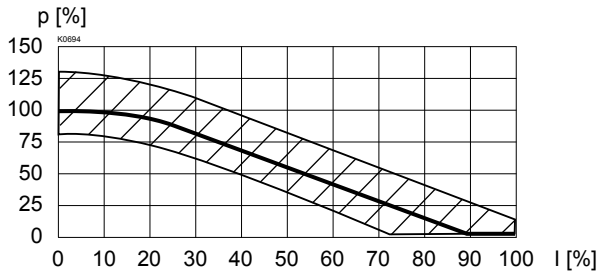

$Q_L = f(p)$  Leakage volume flow characteristics

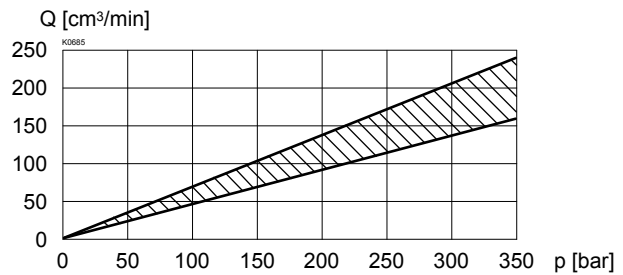

Adjustable range of nominal pressure, adjusted with set screw under the clamp cap.

**DIMENSIONS / SECTIONAL DRAWINGS**

Adjustment screw to set the nominal pressure (+20 % / -30 %)

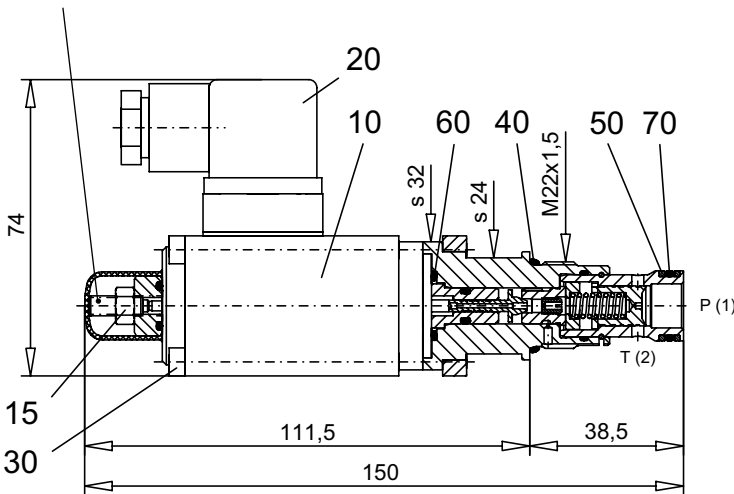

Cavity drawing to  
ISO 7789-22-02-0-98

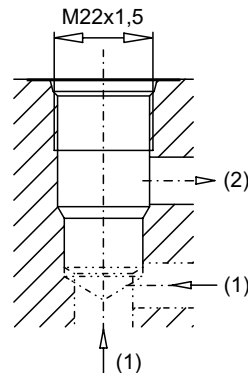

For detailed cavity drawing and cavity tools see data sheet 2.13-1003

**PARTS LIST**

Position	Article	Description
10	256.3497 256. ...	Proportional solenoid PI35V-G24-M152 Proportional solenoid PI35V-G12-M152
15	253.8012 123.9030	Manual override HB4,5-H44 Clamp cap
20	219.2002	Plug B (black)
30	246.1171	Socket head cap screw M4x70 DIN 912
40	160.2188	O-ring ID 18,77x1,78
50	160.2140	O-ring ID 14,00x1,78
60	160.2140	O-ring ID 14,00x1,78
70	049.3177	Back-up ring RD 14,6x17,5x1,4

**ACCESSORIES**

Cartridge built-in flange- or sandwich body  
Flange/Sandwichplate Register 2.3  
Proportional amplifier Register 1.13

Technical explanation see data sheet 1.0-100