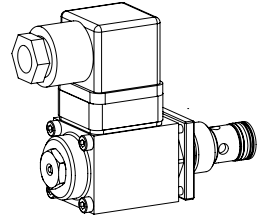

**Proportional pressure relief cartridge**

- ◆ direct operated
- ◆  $Q_{max} = 8 \text{ l/min}$
- ◆  $p_{max} = 350 \text{ bar}$
- ◆  $p_{Nmax} = 315 \text{ bar}$

**M18 x 1,5**  
**ISO 7789**

**DESCRIPTION**

Direct operated proportional pressure relief valve in screw-in cartridge construction for cavity according to ISO 7789. Good flow capacity due to the differential area principle, very sensitively adjustable. When the operating pressure adjusted by means of the proportional solenoid is reached, the valve opens and connects the protected line with the drain to the tank. The back pressure in T (2) affects the pressure in P (1). For the control, Wandfluh proportional amplifiers are available (see register 1.13).

**APPLICATION**

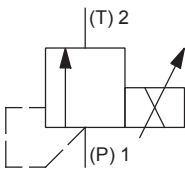
The electrical remote control in conjunction with process controls allows economical solutions with repeatable processes. The screw-in cartridge is perfectly suitable for installation in control blocks and is installed in sandwich- (vertical stacked systems) and in flange plates (corresponding data sheets in this register). For machining the cartridge cavity in steel and aluminum blocks, cavity tools are available (hire or purchase). Please refer to the data sheets in register 2.13.

**SYMBOL**

**ACTUATION**

Actuation	Proportional solenoid, wet pin push type, pressure tight
Execution	PI29V (Data sheet 1.1-90)
Connection	Connector socket EN 175301 – 803

**TYPE CODE**

Pressure relief valve					B	D	P	PM18	-		-		-		#	
Direct operated																
Proportional																
Screw-in cartridge M18 x 1,5																
Nominal pressure range $p_N$	20 bar	<input type="text" value="20"/>	200 bar	<input type="text" value="200"/>												
	100 bar	<input type="text" value="100"/>	315 bar	<input type="text" value="315"/>												
Nominal voltage $U_N$	12 VDC	<input type="text" value="G12"/>														
	24 VDC	<input type="text" value="G24"/>														
Sealing material	NBR	<input type="text" value=""/>														
	FKM (Viton)	<input type="text" value="D1"/>														
Design index (subject to change)																

2.3-520

**GENERAL SPECIFICATIONS**

Designation	Proportional pressure relief valve
Construction	Direct operated
Mounting	Screw-in cartridge construction
Nominal size	M18 x 1,5 according to ISO 7789
Actuation	Proportional solenoid
Ambient temperature	-25...+70 °C
Weight	0,25 kg
MTTFd	150 years

**ELECTRICAL SPECIFICATIONS**

Protection class	IP65
Relative duty factor	100 % DF
Standard nominal voltage	12 VDC, 24 VDC
Limiting current at 50 °C	$I_G = 1080 \text{ mA}$ (12 VDC) $I_G = 540 \text{ mA}$ (24 VDC)

**Note!** Other electrical specifications see data sheet 1.1-90

**HYDRAULIC SPECIFICATIONS**

Working pressure	$p_{\max} = 350 \text{ bar}$
Nominal pressure range	$P_N = 20 \text{ bar}, 100 \text{ bar}, 200 \text{ bar}, 315 \text{ bar}$
Maximum volume flow	$Q_{\max} = 8 \text{ l/min}$ ( $p_N = 20 / 100 \text{ bar}$ ) $Q_{\max} = 6 \text{ l/min}$ ( $p_N = 200 \text{ bar}$ ) $Q_{\max} = 3 \text{ l/min}$ ( $p_N = 315 \text{ bar}$ )
Minimum volume flow	$Q_{\min} = 0,1 \text{ l/min}$
Leakage oil	See characteristics
Hysteresis	$\leq 2 \%$ at optimal dither signal
Repeatability	$\leq 1 \%$ at optimal dither signal
Fluid	Mineral oil, other fluid on request
Viscosity range	12 mm <sup>2</sup> /s...320 mm <sup>2</sup> /s
Temperature range fluid	-25...+70 °C (NBR) -20...+70 °C (FKM)
Contamination efficiency	Class 18 / 16 / 13
Filtration	Required filtration grade $\beta_{6...10} \geq 75$ , see data sheet 1.0-50

**PERFORMANCE SPECIFICATIONS**

Oil viscosity  $\nu = 30 \text{ mm}^2/\text{s}$

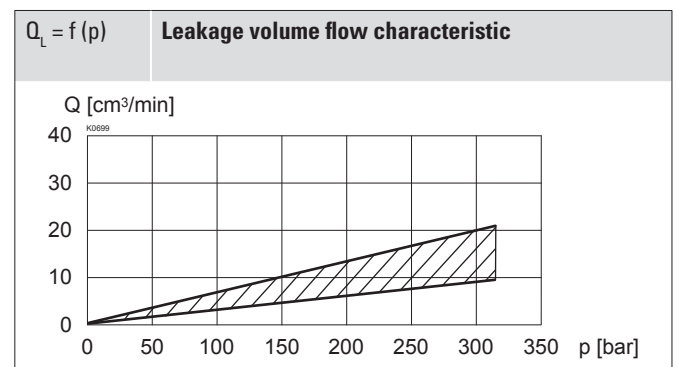
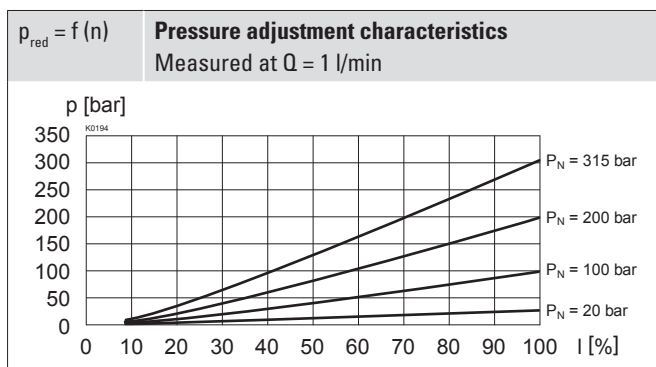
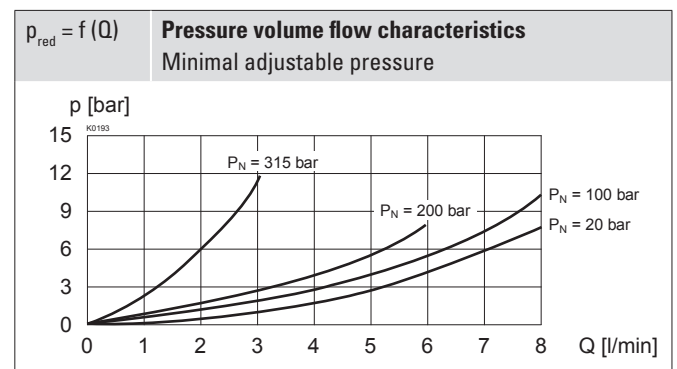
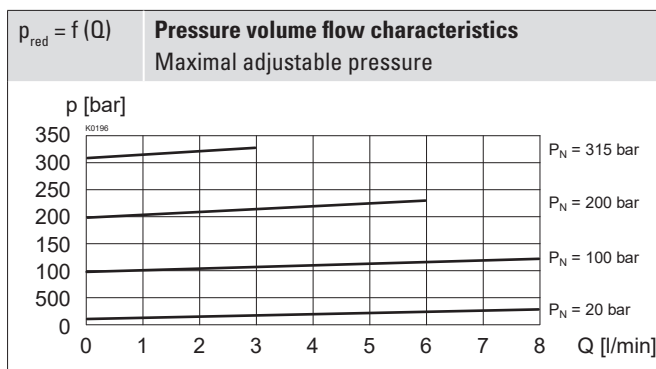

## DIMENSIONS

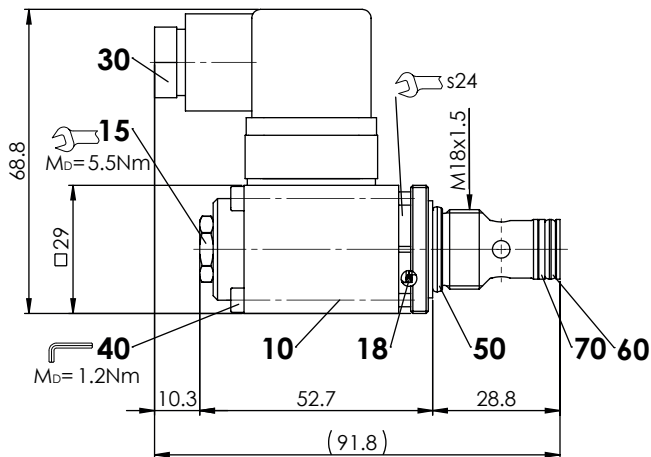

## HYDRAULIC CONNECTION

Cavity drawing according to ISO 7789-18-02-0-98

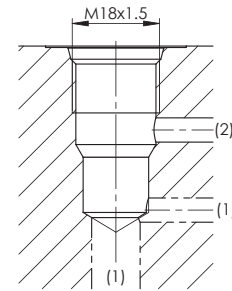

Note!



For detailed cavity drawing and cavity tools see data sheet 2.13-1001

## PARTS LIST

Position	Article	Description
10	256.2418	Proportional solenoid PI29V-G12
	256.2453	Proportional solenoid PI29V-G24
15	253.8000	Manual override HB4,5
30	219.2002	Electric plug B (black)
40	249.0006	Socket head screw M3 x 42
	251.1005	Seal kit B.PPM18
	251.1007	Seal kit B.PPM18.D1

### Seal kit consisting of:

18	O-ring	ID 12,42 x 1,78
50	O-ring	ID 15,60 x 1,78
60	O-ring	ID 9,25 x 1,78
70	Back. ring	PTFE rd 10,6 x 13,5 x 1,4

## ACCESSORIES

Proportional amplifier	Register 1.13
Flange body / sandwich plate NG3-Mini	Data sheet 2.3-700
Threaded body	Data sheet 2.9-200
Technical explanations	Data sheet 1.0-100
Filtration	Data sheet 1.0-50

## MANUAL OVERRIDE

HB4,5 as standard

## SURFACE TREATMENT

- ◆ All external parts of the cartridge as well the solenoid coil are zinc-nickel coated

## SEALING MATERIAL

NBR or FKM (Viton) as standard, choice in the type code

## STANDARDS

Cartridge cavity	ISO 7789
Solenoids	DIN VDE 0580
Connection execution D	EN 175301 – 803
Protection class	EN 60 529
Contamination efficiency	ISO 4406

## INSTALLATION NOTES

Mounting type	Screw-in cartridge M18 x 1,5
Mounting position	Any, preferably horizontal
Tightening torque	$M_D = 40 \text{ Nm}$ Screw-in cartridge $M_D = 1,2 \text{ Nm}$ solenoid screws