

## Solenoid operated poppet valve

### Flange construction

- ◆ 2/2-, 3/2- and 3/4-way
- ◆ normally open and normally closed
- ◆  $Q_{max} = 40 \text{ l/min}$
- ◆  $p_{max} = 350 \text{ bar}$

### DESCRIPTION

Direct operated 2/2-, 3/2 and 3/4-way solenoid poppet valve in flange construction. By means of the pressure tight switching solenoid, the poppet valve spool is opened or closed acting against the spring. Due to the poppet spool construction with pressure compensation on both sides, the flow through the valve is possible in both directions. The metallic sealing seat closes the valve virtually leak free. The pressure tight encapsulated Ex-protection solenoid coil prevents an explosion on the inside penetrating to the outside as well as an ignitable surface temperature.

### CERTIFICATES

	Surface	Mining	Standard -25 °C to...	Z604 -40 °C to...	Z591 -60 °C to...
ATEX	x	x	x	x	x
IECEX	x	x	x	x	x
CCC	x	x	x	x	x
EAC	x	x	x	x	x
Australia	x	x	x	x	
MA		x	x		
UL / CSA	x		x	x	

The certificates can be found on [www.wandfluh.com](http://www.wandfluh.com)

### NG6

#### ISO 4401-03

- ⊕ II 2 G Ex db IIC T6, T4
  - ⊕ II 2 D Ex tb III C T80 °C, T130 °C
  - ⊕ I M2 Ex db I Mb
- Class I Division 1  
Class I Zone 1

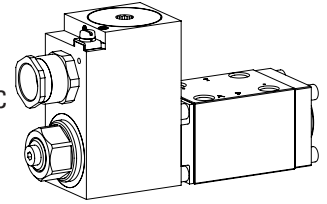

### APPLICATION

These valves are suitable for applications in explosion-hazard areas, open cast and also in mines. Poppet valves are used where tight closing functions of the valve are essential like leakage-free load holding, clamping or gripping.

### ACTUATION

Actuation	Switching solenoid, wet pin push type, pressure tight
Execution	MKY45 / 18x60 (data sheet 1.1-183) MKU45 / 18x60 (data sheet 1.1-184)
Connection	Cable gland for cable $\varnothing 6,5 \dots 14 \text{ mm}$

**Attention!** The UL execution is always supplied without cable gland



### STANDARDS

Explosion protection	Directive 2014 / 34 / EU (ATEX)
Flameproof enclosure	EN / IEC 60079-1 / 31
Cable entry	EN 60079-0, 1, 7, 15, 31
Mounting interface	ISO 4401-03
Protection class	EN 60 529
Contamination efficiency	ISO 4406

### SYMBOL

A.22060b

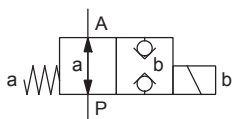

A.22061a

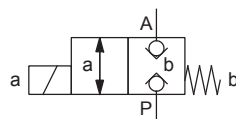

A.32060b

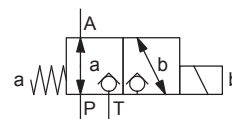

A.32061a

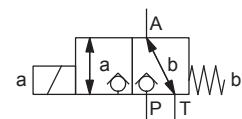

A.3406

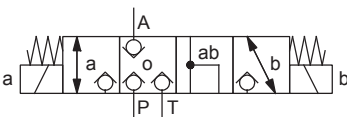

**TYPE CODE**

 2/2 or 3/2 way execution  
 3/4 way execution

 A Exd  2 06  -  /  /  -  #   
 A Exd 3 4 06  -  /  /  -  # 

International standard interface ISO

Explosion-proof execution, Ex d

 2 way (connections)  2  
 3 way (connections)  3

 2 switching positions  
 4 switching positions

Nominal size 6

 Normally closed Solenoid on A-side  1a  
 Normally open Solenoid on B-side  0b

 Nominal voltage  $U_N$  12 VDC  G12 115 VAC  R115  
 24 VDC  G24 230 VAC  R230

 Nominal power  $P_N$  9 W  L9  
 15 W  L15  
 17 W  L17  
*Ambient temperature up to:*  
 40 °C or 90 °C  
 70 °C  
 70 °C (only UL / CSA)

 Certification ATEX, IECEx, EAC, CCC   
 Australia  AU UL / CSA  UL MA  MA

 Sealing material / Temperature range NBR   
 FKM (Viton)  D1  
 NBR -40 °C  Z604 (only with 15 W)  
 -60 °C to...  Z591 (only with 15 W / ATEX and IECEx / Surface)

Design index (subject to change)

1.11-3143

**GENERAL SPECIFICATIONS**

Designation	2/2-, 3/2- and 3/4-way poppet valve
Construction	Direct operated
Mounting	Flange construction
Nominal size	NG6 according to ISO 4401-03
Actuation	Ex-protection switching solenoid
Ambient temperature	<b>Operation as T6</b> -25...+40 °C (L9) <b>Operation as T4</b> -25...+90 °C (L9) -25...+70 °C (L15 / L17) -40...+70 °C (L15 / L17)
Weight	3,3 kg (2/2- and 3/2-way) 5,4 kg (3/4-way)
MTTFd	150 years

**HYDRAULIC SPECIFICATIONS**

Working pressure	$p_{max} = 350$ bar
Maximum volume flow	$Q_{max} = 40$ l/min, see characteristic
Volume flow direction	Any (see characteristic)
Leakage oil	Poppet type, max. 0,05 ml / min (approx. 1 drop / min) at 30 cSt
Fluid	Mineral oil, other fluid on request
Viscosity range	12 mm <sup>2</sup> /s...320 mm <sup>2</sup> /s
Temperature range fluid	<b>Operation as T6</b> NBR -25...+40 °C (L9) FKM -20...+40 °C (L9) <b>Operation as T4</b> NBR -25...+70 °C (L9 or L15 / L17) FKM -20...+70 °C (L9 or L15 / L17) NBR 872 -40...+70 °C (L15 / L17)
Contamination efficiency	Class 20 / 18 / 14
Filtration	Required filtration grade $\beta_{10...16} \geq 75$ , see data sheet 1.0-50

## PERFORMANCE SPECIFICATIONS

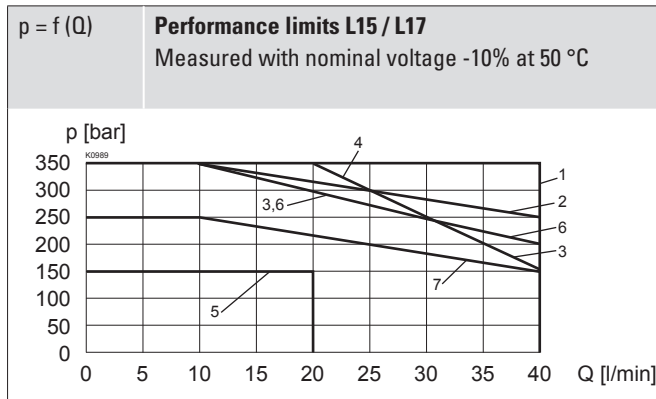
 Oil viscosity  $\nu = 30 \text{ mm}^2/\text{s}$ 

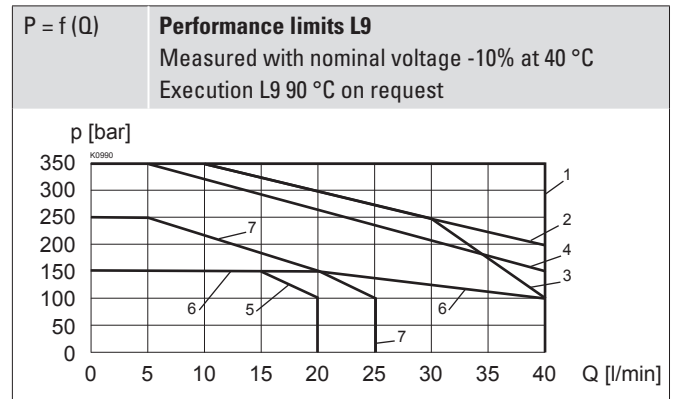

Type	Flow direction			
	P - A	A - T	A - P	T - A
AEXd22061a	1	-	6	-
AEXd22060b	1	-	3	-
AEXd32061a	1	2	5	1
AEXd32060b	1	4	7	1
AEXd3406	1	1	6	6

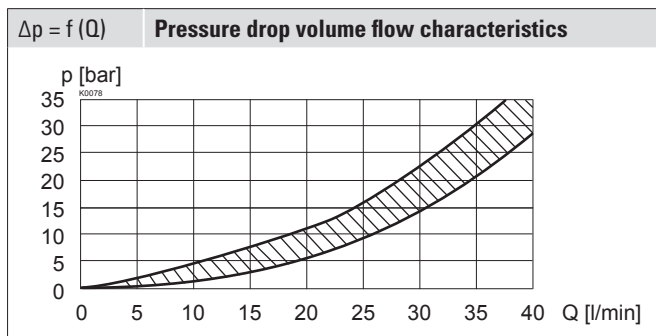

Type	Flow direction			
	P - A	A - T	A - P	T - A
AEXd22061a	1	-	6	-
AEXd22060b	1	-	3	-
AEXd32061a	1	2	5	1
AEXd32060b	1	4	7	1
AEXd3406	1	1	6	6



**Note!**  With the L15 / L17 execution for ambient temperatures up to 70 °C, the performance specifications have been evaluated with an ambient temperature of 50 °C

**Attention!**  Long periods of non-actuation can reduce the switching performance

### SURFACE TREATMENT

- ◆ The valve body is painted with a two component paint
- ◆ The cover, the slip-on coil and the armature tube are zinc-nickel coated

### VALVES INSTALLED

The central functioning element is the poppet valve cartridge NG6, data sheet 1.11-2030.

## ELECTRICAL SPECIFICATIONS

Protection class	IP67
Relative duty factor	100 % DF
Switching frequency	12'000 / h
Voltage tolerance	$\pm 10 \%$ with regard to nominal voltage
Standard nominal voltage	12 VDC, 24VDC, 115 VAC, 230 VAC AC = 50 to 60 Hz $\pm 2 \%$ , with built-in two-way rectifier
Standard nominal power	9 W, 15 W, 17 W
Temperature class	Nominal power 9 W: T1...T6 Nominal power 15 W / 17 W: T1...T4

**Note!**  Other electrical specifications see data sheet 1.1-183 and 1.1-184

### SEALING MATERIAL

NBR or FKM (Viton) as standard, choice in the type code

### MANUAL OVERRIDE

Screw plug (HB0), no actuation possible  
 Optionally: HB6, HN(K) or HG(K)  
 → See data sheet 1.1-311

## DIMENSIONS

3/2-; 2/2-way

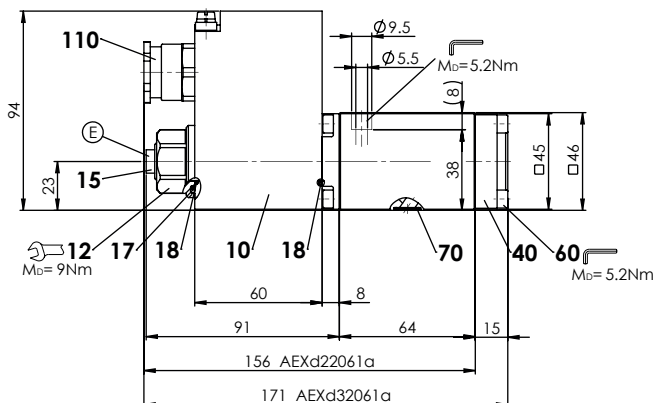

E = Air bleed screw

Dimensions of the solenoid coil see data sheet 1.1-183 and 1.1-184

3/4-way

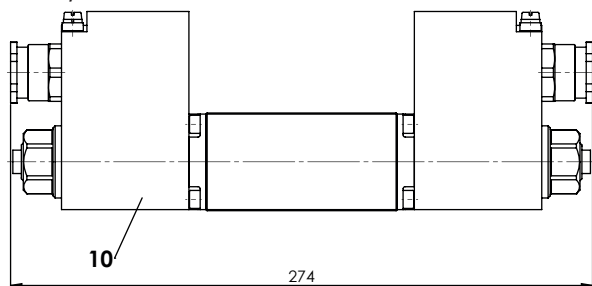

## PARTS LIST

Position	Article	Description
10	263.6...	Solenoid coil MK.45 / 18 x 60
12	154.2603	Knurled nut Ex M18 x 1,5 x 18
15	239.2033	Screw plug HB0 (incl. seal)
	239.2043	Screw plug HB0-H40-Z591 (incl. seal)
17	160.2251	O-ring ID 25,07 x 2,62 (NBR)
18	160.2170	O-ring ID 17,17 x 1,78 (NBR)
40	058.4215	Cover
60	246.2117	Socket head screw M5 x 16 DIN 912
70	160.2093	O-ring ID 9,25 x 1,78 (NBR)
	160.7092	O-ring ID 9,25 x 1,78 (NBR -40 °C)
	160.0091	O-ring ID 9,25 x 1,78 (Polyurethan -60 °C)
	160.6092	O-ring ID 9,25 x 1,78 (FKM)
110	111.1080	Cable gland M20 x 1,5

## COMMISSIONING

**Attention!** When commissioning, the valve must be vented under pressure (max. two rotations of screw E).



The solenoid coil must only be put into operation, if the requirements of the operating instructions supplied are observed to their full extent. In case of non-observance, no liability is assumed.

3/2-; 2/2-way

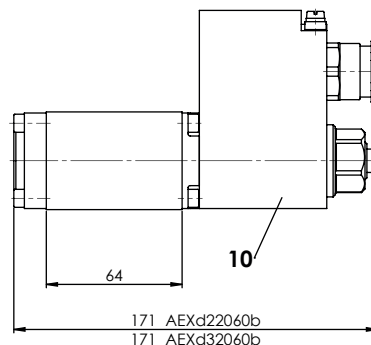

## HYDRAULIC CONNECTION

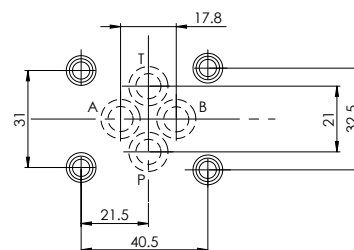

## ACCESSORIES

Fixing screws	Data sheet 1.0-60
Threaded subplates	Data sheet 2.9-05
Multi-station subplates	Data sheet 2.9-45
Horizontal mounting blocks	Data sheet 2.9-85
Technical explanations	Data sheet 1.0-100
Hydraulic fluids	Data sheet 1.0-50
Filtration	Data sheet 1.0-50
Relative duty factor	Data sheet 1.1-430

## INSTALLATION NOTES

Mounting type	Flange mounting 4 fixing holes for socket head screws M5 x 45
Mounting position	Any, preferably horizontal
Tightening torque	Fixing screws $M_D = 5,2 \text{ Nm}$ (screw quality 8.8, zinc coated) $M_D = 5 \text{ Nm}$ knurled nut

### Note!



The length of the fixing screw depends on the base material of the connection element. For valves for the temperature range „-60 °C to...“ (Z591), screws of the quality A4 have to be used.

### Attention!



For stack assembly please observe the remarks in the operating instructions

**Wandfluh AG** Postfach CH-3714 Frutigen  
 Tel. +41 33 672 72 72 Fax +41 33 672 72 12 sales@wandfluh.com