

Solenoid operated poppet valve stainless

Flange construction

- ◆ 2/2- or 3/2-way
- ◆ normally open and normally closed
- ◆ $Q_{max} = 40 \text{ l/min}$
- ◆ $p_{max} = 350 \text{ bar}$

DESCRIPTION

Direct operated 2/2- and 3/2-way poppet valve in flange construction. By means of the pressure tight switching solenoid, the poppet valve spool is opened or closed acting against the spring. Due to the poppet spool construction with pressure compensation on both sides, the flow through the valve is possible in both directions. The metallic sealing seat closes the valve virtually leak free. The pressure tight encapsulated Ex-protection solenoid coil prevents an explosion on the inside penetrating to the outside as well as an ignitable surface temperature.

CERTIFICATES

	Surface	Mining	Standard -25 °C to...	Z604 -40 °C to...
ATEX	x	x	x	x
IECEX	x	x	x	x
CCC	x	x	x	x
EAC	x	x	x	x
Australia	x	x	x	x
MA		x	x	
UL / CSA	x		x	x

The certificates can be found on www.wandfluh.com

NG6

ISO 4401-03

- ⊕ II 2 G Ex db IIC T6, T4
 - ⊕ II 2 D Ex tb III C T80 °C, T130 °C
 - ⊕ I M2 Ex db I Mb
- Class I Division 1
Class I Zone 1

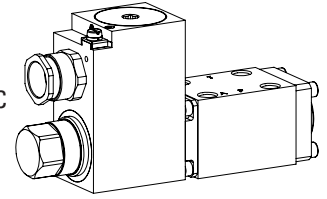

APPLICATION

These valves are suitable for applications in explosion-hazard areas, open cast and also in mines. The stainless execution is especially suitable for the use in wet and salty environment. Poppet valves are used where tight closing functions of the valve are essential like leakage-free load holding, clamping or gripping.

ACTUATION

Actuation	Switching solenoid, wet pin push type, pressure tight
Execution	MKY45 / 18x60 (data sheet 1.1-183) MKU45 / 18x60 (data sheet 1.1-184)
Connection	Cable gland for cable Ø 6,5...14 mm

Attention! The UL execution is always supplied without cable gland



STANDARDS

Explosion protection	Directive 2014 / 34 / EU (ATEX)
Flameproof enclosure	EN / IEC / UL 60079-1, 31
Cable entry	EN 60079-0, 1, 7, 15, 31
Mounting interface	ISO 4401-03
Protection class	EN 60 529
Contamination efficiency	ISO 4406

SYMBOL

A.22060b

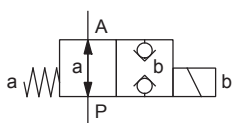

A.22061a

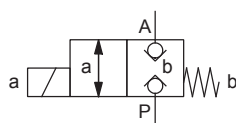

A.32060b

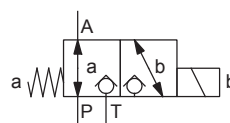

A.32061a

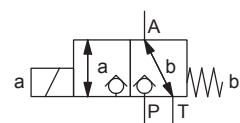

TYPE CODE

International standard interface ISO		A Exd <input type="checkbox"/> 2 06 <input type="checkbox"/> - <input type="checkbox"/> / <input type="checkbox"/> / <input type="checkbox"/> - <input type="checkbox"/> # <input type="checkbox"/>		
Explosion-proof execution, Ex d				
2 way (connections)	<input type="checkbox"/> 2			
3 way (connections)	<input type="checkbox"/> 3			
2 switching positions				
Nominal size 6				
Normally closed	Solenoid on A-side	<input type="checkbox"/> 1a		
Normally open	Solenoid on B-side	<input type="checkbox"/> 0b		
Nominal voltage U_N	12 VDC	<input type="checkbox"/> G12	115 VAC	
	24 VDC	<input type="checkbox"/> G24	230 VAC	
Nominal power P_N	9 W	<input type="checkbox"/> L9	Ambient temperature up to: 40 °C or 90 °C	
	15 W	<input type="checkbox"/> L15		70 °C
	17 W	<input type="checkbox"/> L17	70 °C (only UL / CSA)	
Certification	ATEX, IECEx, EAC, CCC	<input type="checkbox"/>		
	Australia	<input type="checkbox"/> AU	UL / CSA <input type="checkbox"/> UL MA <input type="checkbox"/> MA	
Sealing material / Temperature range	NBR	<input type="checkbox"/>		
	FKM (Viton)	<input type="checkbox"/> D1		
	NBR -40 °C	<input type="checkbox"/> Z604	(only with 15 W)	
Stainless	with K8 coil	<input type="checkbox"/> K9	(not for UL execution)	
	with K9 coil	<input type="checkbox"/> K10		

Design index (subject to change)

1.11-3143S

GENERAL SPECIFICATIONS

Designation	2/2-, 3/2-way poppet valve
Construction	Direct operated
Mounting	Flange construction
Nominal size	NG6 according to ISO 4401-03
Actuation	Ex-protection switching solenoid
Ambient temperature	Operation as T6 -25...+40 °C (L9) Operation as T4 -25...+90 °C (L9) -25...+70 °C (L15 / L17) -40...+70 °C (L15 / L17)
Weight	3,3 kg
MTTFd	150 years

HYDRAULIC SPECIFICATIONS

Working pressure	$p_{max} = 350$ bar
Maximum volume flow	$Q_{max} = 40$ l/min, see characteristic
Volume flow direction	Any (see characteristic)
Leakage oil	Poppet type, max. 0,05 ml / min (approx. 1 drop / min) at 30 cSt
Fluid	Mineral oil, other fluid on request
Viscosity range	12 mm ² /s...320 mm ² /s
Temperature range fluid	Operation as T6 NBR -25...+40 °C (L9) FKM -20...+40 °C (L9) Operation as T4 NBR -25...+70 °C (L9 or L15 / L17) FKM -20...+70 °C (L9 or L15 / L17) NBR 872 -40...+70 °C (L15 / L17)
Contamination efficiency	Class 20 / 18 / 14
Filtration	Required filtration grade $\beta_{10} \dots \beta_{16} \geq 75$, see data sheet 1.0-50

PERFORMANCE SPECIFICATIONS

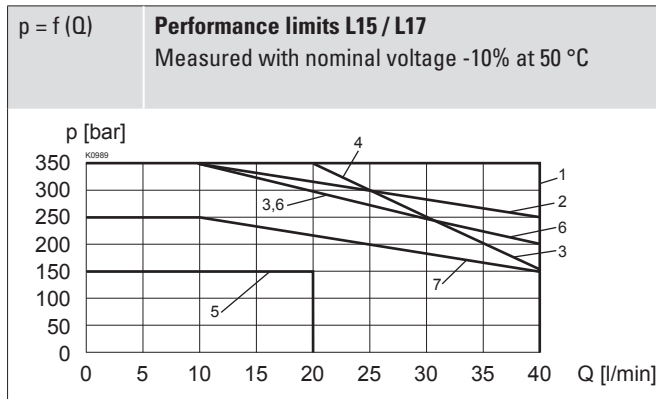
 Oil viscosity $\nu = 30 \text{ mm}^2/\text{s}$

Type	Flow direction			
	P - A	A - T	A - P	T - A
AEXd22061a	1	-	6	-
AEXd22060b	1	-	3	-
AEXd32061a	1	2	5	1
AEXd32060b	1	4	7	1

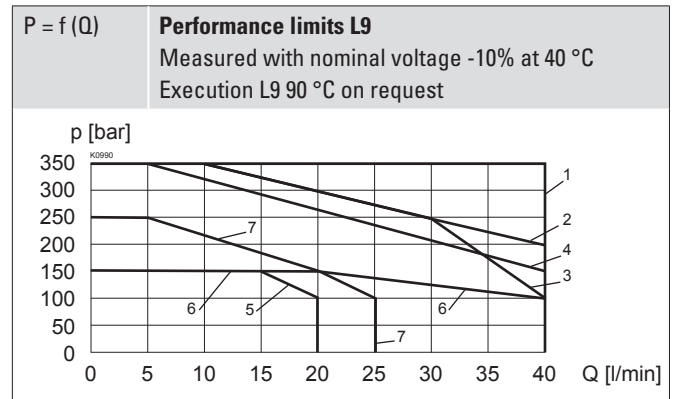

Type	Flow direction			
	P - A	A - T	A - P	T - A
AEXd22061a	1	-	6	-
AEXd22060b	1	-	3	-
AEXd32061a	1	2	5	1
AEXd32060b	1	4	7	1

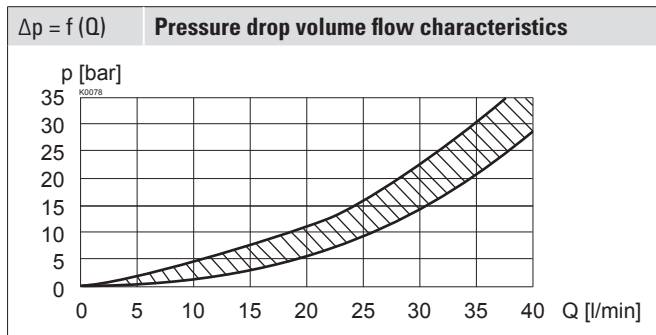

Note!  With the L15 / L17 execution for ambient temperatures up to 70 °C, the performance specifications have been evaluated with an ambient temperature of 50 °C

Attention!  Long periods of non-actuation can reduce the switching performance

SURFACE TREATMENT

-The valve body, the cover and the socket head screws are made of stainless steel

-The slip-on coil and the armature tube are zinc nickel coated

Optionally K10:

-The coil is made of stainless steel

VALVES INSTALLED

The central functioning element is the poppet valve cartridge NG6, data sheet 1.11-2030.

ELECTRICAL SPECIFICATIONS

Protection class	IP65 / 66 / 67
Relative duty factor	100 % DF
Switching frequency	12'000 / h
Voltage tolerance	$\pm 10 \%$ with regard to nominal voltage
Standard nominal voltage	12 VDC, 24VDC, 115 VAC, 230 VAC AC = 50 to 60 Hz $\pm 2 \%$, with built-in two-way rectifier
Standard nominal power	9 W, 15 W, 17 W
Temperature class	Nominal power 9 W: T1...T6 Nominal power 15 W / 17 W: T1...T4

Note!  Other electrical specifications see data sheet 1.1-183 and 1.1-184

SEALING MATERIAL

NBR or FKM (Viton) as standard, choice in the type code

MANUAL OVERRIDE

Screw plug (HB0), no actuation possible

Optionally: HB6, HN(K) or HG(K)

→ See data sheet 1.1-311

DIMENSIONS

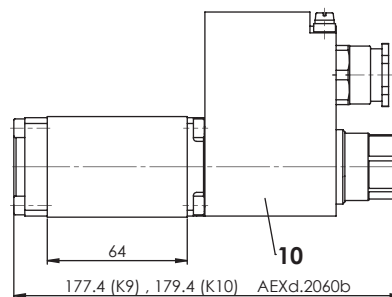
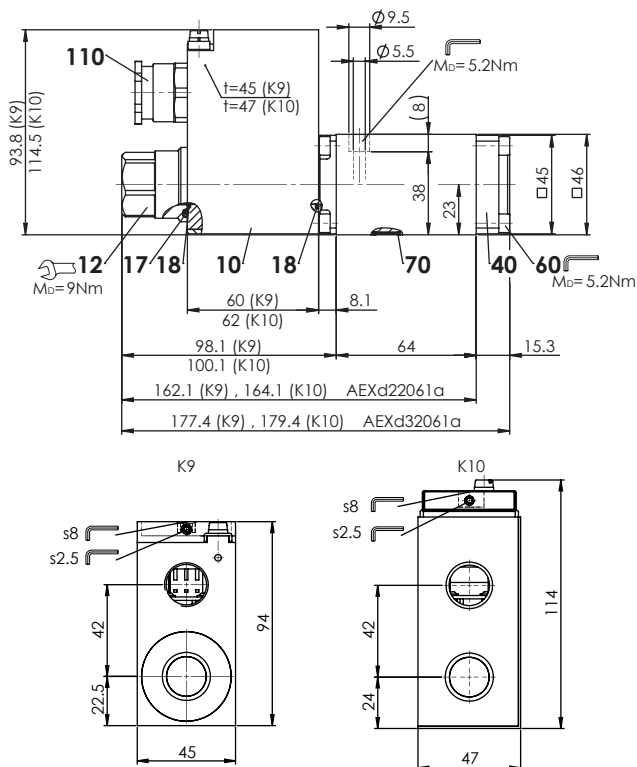

Note! The K9 coil (K10 valve) is 1 mm larger than the valve body. Usually, a distance plate is necessary.



HYDRAULIC CONNECTION

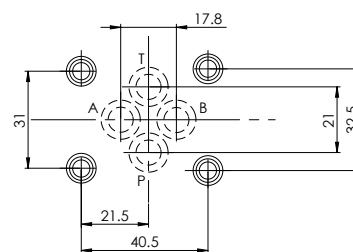

Dimensions of the solenoid coil see data sheet 1.1-183, 1.1-183S and 1.1-184

PARTS LIST

Position	Article	Description
10	263.6...	Solenoid coil MK.45 / 18 x 60
12	154.2201	Knurled nut Ex M18 x 1,5 x 30
17	160.2251	O-ring ID 25,07 x 2,62 (NBR)
18	160.2170	O-ring ID 17,17 x 1,78 (NBR)
40	058.4221	Cover 45 /45 x 17,5 K9
60	246.2516	Socket head screw M5 x 16 A4 DIN 912
70	160.2093	O-ring ID 9,25 x 1,78 (NBR) „-25 °C to...“
	160.7092	O-ring ID 9,25 x 1,78 (NBR) „-40 °C to...“
	160.6092	O-ring ID 9,25 x 1,78 (FKM)
110	111.1080	Cable gland M20 x 1,5

COMMISSIONING

Attention! The solenoid coil must only be put into operation, if the requirements of the operating instructions supplied are observed to their full extent. In case of non-observance, no liability can be assumed.



INSTALLATION NOTES

Mounting type	Flange mounting 4 fixing holes for socket head screws M5 x 45
Mounting position	Any, preferably horizontal
Tightening torque	Fixing screws $M_D = 5,1 \text{ Nm}$ (screw quality A4) $M_D = 9 \text{ Nm}$ knurled nut

Note! The length of the fixing screw depends on the base material of the connection element.



Attention! For stack assembly please observe the remarks in the operating instructions



ACCESSORIES

Technical explanations	Data sheet 1.0-100
Filtration	Data sheet 1.0-50
Relative duty factor	Data sheet 1.1-430