

Solenoid operated poppet valve

Flange construction

- ◆ 2/2-, 3/2- and 3/4-way
- ◆ normally open and normally closed
- ◆ $Q_{max} = 15 \text{ l/min}$
- ◆ $p_{max} = 350$

DESCRIPTION

Direct operated 2/2-, 3/2 and 3/4-way solenoid poppet valve in flange construction. By means of the pressure tight switching solenoid, the poppet valve spool is opened or closed acting against the spring. Due to the poppet spool construction with pressure compensation on both sides, the flow through the valve is possible in both directions. The seat spool guide is sealed by means of an O-ring. The metallic sealing seat closes the valve virtually leak free.

NG4-Mini Wandfluh standard

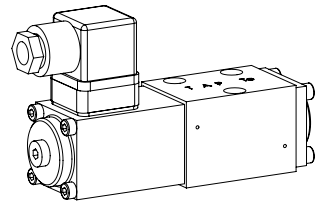

APPLICATION

Poppet valves are used where tight closing functions of the valve are essential like leakage-free load holding, clamping or gripping. Miniature valves are used where both, reduced dimensions and weight are important.

SYMBOL

B.22040b

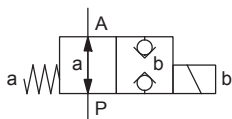

B.22041a

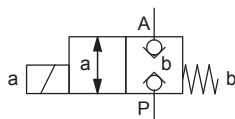

B.32040b

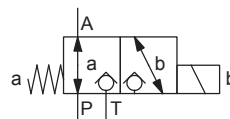

B.32041a

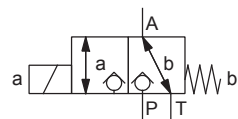

B.3404

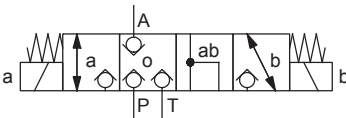

TYPE CODE

2/2 or 3/2 way execution

3/4 way execution

B	<input type="checkbox"/>	<input type="checkbox"/>	2	04	<input type="checkbox"/>	-	<input type="checkbox"/>	-	<input type="checkbox"/>	#	<input type="checkbox"/>
B	<input type="checkbox"/>	<input type="checkbox"/>	3	04	<input type="checkbox"/>	-	<input type="checkbox"/>	-	<input type="checkbox"/>	#	<input type="checkbox"/>

Mounting interface acc. to Wandfluh standard

Solenoid, Medium

 M

Solenoid, Super

 S

2 way (connections)

 2

3 way (connections)

 3

2 switching positions

4 switching positions

Nominal size 4-Mini

Normally closed

Solenoid on A-side

 1a

Normally open

Solenoid on B-side

 0b

 Nominal voltage U_N

12 VDC

 G12

115 VAC

 R115

24 VDC

 G24

230 VAC

 R230

Sealing material

NBR

FKM (Viton)

 D1

Design index (subject to change)

1.11-2120

GENERAL SPECIFICATIONS

Designation	2/2-, 3/2- and 3/4-way poppet valve
Construction	Direct operated
Mounting	Flange construction
Nominal size	NG4-Mini according to Wandfluh standard
Actuation	Switching solenoid
Ambient temperature	-25...+70 °C
Weight	0,95 kg (2/2- and 3/2-way) 1,45 kg (3/4-way)
MTTFd	150 years

ELECTRICAL SPECIFICATIONS

Protection class	IP65
Relative duty factor	100 % DF
Switching frequency	15'000 / h
Service life time	10 ⁷ (number of switching cycles, theoretically)
Voltage tolerance	± 10 % with regard to nominal voltage
Standard nominal voltage	12 VDC, 24VDC, 115 VAC, 230 VAC AC = 50 to 60 Hz, rectifier integrated in the connector socket

Note! Other electrical specifications see data sheet 1.1-105 (Medium) and 1.1-110 (Super)

ACTUATION

Actuation	Switching solenoid, wet pin push type, pressure tight
Execution	Medium: SIN35V (Data sheet 1.1-105) Super: SIS35V (Data sheet 1.1-110)
Connection	Connector socket EN 175301 – 803

COMMISSIONING

Attention! When commissioning, the valve must be vented under pressure (max. two rotations of screw E).

HYDRAULIC SPECIFICATIONS

Working pressure	Medium: p _{max} = 160 bar Super: p _{max} = 350 bar
Maximum volume flow	Q _{max} = 15 l/min, see characteristics
Volume flow direction	Any (see characteristic)
Leakage oil	Poppet type, max. 0,05 ml / min (approx. 1 drop / min) at 30 cSt
Fluid	Mineral oil, other fluid on request
Viscosity range	12 mm ² /s...320 mm ² /s
Temperature range fluid	-25...+70 °C (NBR) -20...+70 °C (FKM)
Contamination efficiency	Class 20 / 18 / 14
Filtration	Required filtration grade β 10...16 ≥ 75, see data sheet 1.0-50

PERFORMANCE SPECIFICATIONS

Oil viscosity $\nu = 30 \text{ mm}^2/\text{s}$

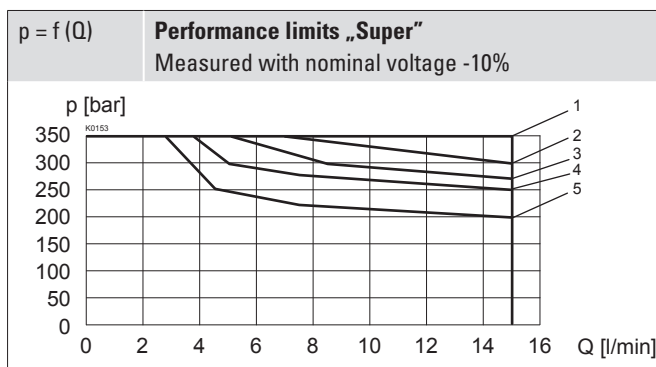
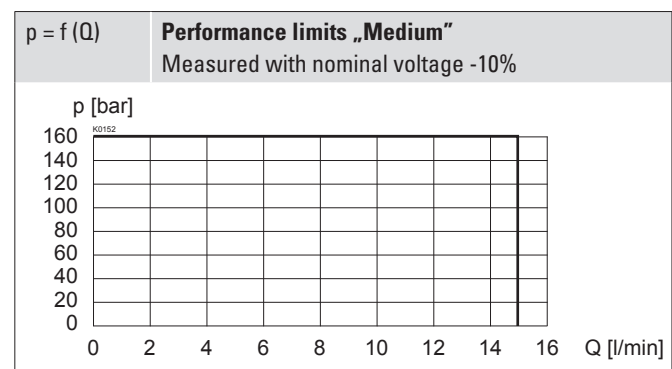
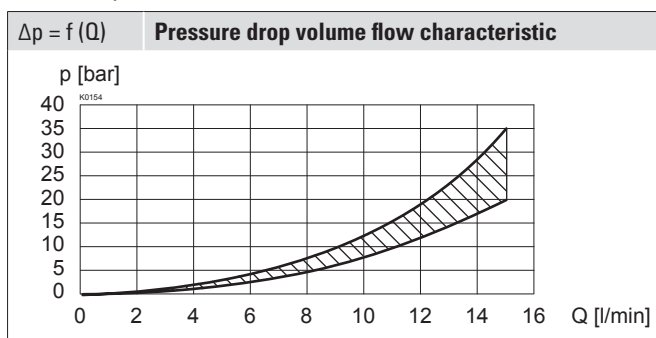

Type	Flow direction			
	P - A	A - T	A - P	T - A
BS22041a	1	-	2	-
BS22040b	1	-	4	-
BS32041a	1	3	5	1
BS32040b	1	4	5	1
BS3404	1	1	2	2

Attention! Long periods of non-actuation can reduce the switching performance



VALVES INSTALLED

The central functioning element is the poppet valve cartridge listed below

Article	Description	Data sheet no.
2204	Solenoid poppet valve cartridge normally closed NG4	1.11-2020

DIMENSIONS

3/2-; 2/2-way

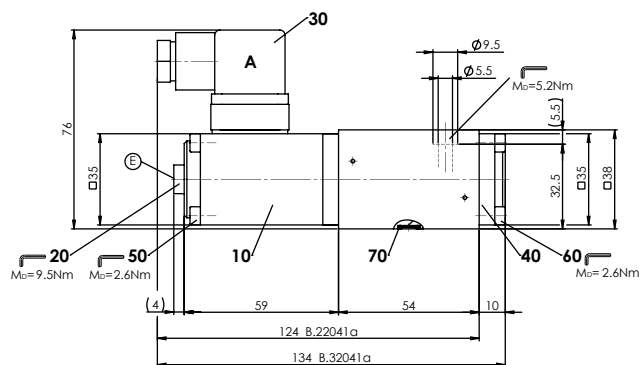

3/2-; 2/2-way

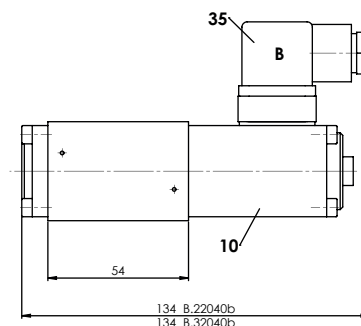

E = Air bleed screw

3/4-way

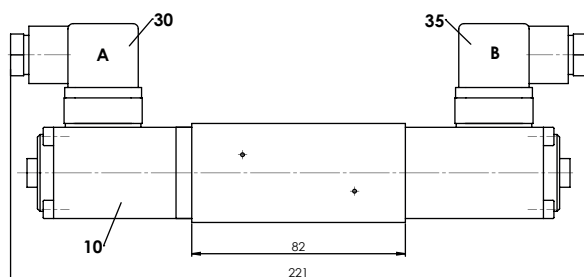

HYDRAULIC CONNECTION

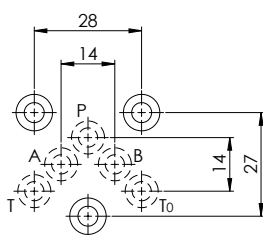

PARTS LIST

Position	Article	Description
10	260.4...	Solenoid SIN35V
	260.5...	Solenoid SIS35V
20	239.2033	Screw plug HB0 (incl. seal)
30	219.2001	Electric plug A (grey)
35	219.2002	Electric plug B (black)
40	057.4201	Cover
50	246.1161	Socket head screw M4 x 60 DIN 912
60	246.1113	Socket head screw M4 x 12 DIN 912
70	160.2052	O-ring ID 5,28 x 1,78 (NBR)
	160.6052	O-ring ID 5,28 x 1,78 (FKM)

SEALING MATERIAL

NBR or FKM (Viton) as standard, choice in the type code

STANDARDS

Mounting interface	Wandfluh standard
Solenoids	DIN VDE 0580
Connection execution D	EN 175301 – 803
Protection class	EN 60 529
Contamination efficiency	ISO 4406

ACCESSORIES

Fixing screws	Data sheet 1.0-60
Threaded subplates	Data sheet 2.9-10
Multi-station subplates	Data sheet 2.9-50
Module type manifold blocks	Data sheet 2.9-90
Technical explanations	Data sheet 1.0-100
Filtration	Data sheet 1.0-50
Relative duty factor	Data sheet 1.1-430

INSTALLATION NOTES

Mounting type	Flange mounting 3 fixing holes for socket head screws M5 x 40
Mounting position	Any, preferably horizontal
Tightening torque	Fixing screws $M_0 = 5,2 \text{ Nm}$ (screw quality 8.8, zinc coated)

Note!



The length of the fixing screw depends on the base material of the connection element.

MANUAL OVERRIDE

Screw plug (HB0), no actuation possible
Optionally: HB4,5, HN(K) or HG(K)
→ See data sheet 1.1-311

SURFACE TREATMENT

- ◆ The valve body is painted with a two component paint
- ◆ The solenoid and the cover are re zinc-nickel coated
- ◆ The socket head screws are zinc coated