

### Solenoid operated poppet valve cartridge

- ◆ solenoid actuated
- ◆ pilot operated
- ◆ normally open and normally closed
- ◆ 2/2-way
- ◆  $Q_{max} = 150 \text{ l/min}$
- ◆  $p_{max} = 350 \text{ bar}$

### M33 x 2 ISO 7789

- ⊕ II 2 G Ex db IIC T6, T4
- ⊕ II 2 D Ex tb III C T80 °C, T130 °C
- ⊕ I M2 Ex db I Mb
- Class I Division 1
- Class I Zone 1

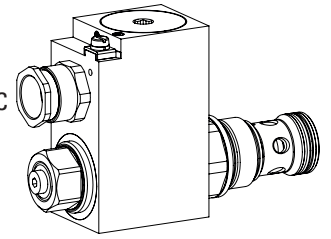

### DESCRIPTION

Pilot operated 2/2-way solenoid poppet valve in screw-in cartridge construction for cavity according to ISO 7789. The AB and CB execution is closed in the energised position, the BA and BC execution in the de-energised position. In this, the main spool closes practically leakage-free by means of the applied pressure. In the opposite flow direction, the valve opens after reaching the opening pressure. The pressure tight encapsulated Ex-protection solenoid coil prevents an explosion on the inside penetrating to the outside as well as an ignitable surface temperature.

### APPLICATION

These valves are suitable for applications in explosion-hazard areas, open cast and also in mines. Poppet valves are used where tight closing functions of the valve are essential like leakage-free load holding, clamping or gripping. For machining the cartridge cavity in steel and aluminum blocks, cavity tools are available (hire or purchase). Please refer to the data sheets in register 2.13.

### CERTIFICATES

	Surface	Mining	Standard -25 °C to...	Z604 -40 °C to...
ATEX / UKEX	x	x	x	x
IECEX	x	x	x	x
CCC	x	x	x	x
EAC	x	x	x	x
Australia	x	x	x	x
MA		x	x	
UL / CSA	x		x	x

The certificates can be found on [www.wandfluh.com](http://www.wandfluh.com)

### ACTUATION

Actuation	Switching solenoid, wet pin push + pull type, pressure tight
Execution	MKY45 / 18x60 (data sheet 1.1-183) MKU45 / 18x60 (data sheet 1.1-184)
Connection	Cable gland for cable Ø 6,5... 14 mm

**Attention!** The UL execution is always supplied without cable gland



### SYMBOL

„Normally open“ AB

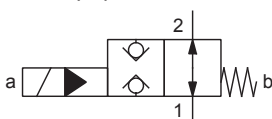

„Normally closed“ BA

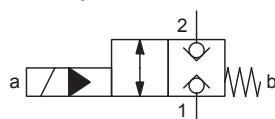

„Normally closed“ BC

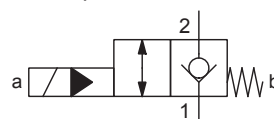

„Normally open“ CB

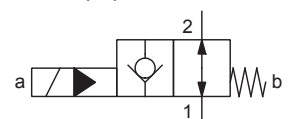

**TYPE CODE**

		S V Y PM33 - <input type="text"/> - <input type="text"/> / <input type="text"/> <input type="text"/> - <input type="text"/> # <input type="text"/>	
Poppet valve			
Pilot operated			
Ex-protection execution, Exd			
Screw-in cartridge M33 x 2			
Designation of symbols acc. to table			
Nominal voltage U <sub>N</sub>	12 VDC 24 VDC	<input type="text"/> G12 <input type="text"/> G24	115 VAC 230 VAC
			<input type="text"/> R115 <input type="text"/> R230 (not for UL)
Nominal power P <sub>N</sub>	9 W 15 W 17 W	<input type="text"/> L9 <input type="text"/> L15 <input type="text"/> L17	<i>Ambient temperature up to:</i> 40 °C or 90 °C 70 °C 70 °C (only UL / CSA)
Certification	ATEX / UKEX, IECEx, EAC, CCC Australia	<input type="text"/> <input type="text"/> AU	UL / CSA <input type="text"/> UL MA <input type="text"/> MA
Sealing material	NBR FKM (Viton) NBR -40° C	<input type="text"/> <input type="text"/> D1 <input type="text"/> Z604	(only with 15 W)
Design index (subject to change)	1.11-2085		

**GENERAL SPECIFICATIONS**

Designation	2/2-way poppet valve
Construction	Pilot operated
Mounting	Screw-in cartridge construction
Nominal size	M33 x 2 according to ISO 7789
Actuation	Ex-protection switching solenoid
Ambient temperature	<b>Operation as T6</b> -25...+40 °C (L9) <b>Operation as T4</b> -25...+90 °C (L9) -25...+70 °C (L15 / L17) -40...+70 °C (L15 / L17)
Weight	2,45 kg
MTTFd	150 years

**HYDRAULIC SPECIFICATIONS**

Working pressure	p <sub>max</sub> = 350 bar
Opening pressure	1,5 bar 1 → 2 version BC / CB 2,0 bar 2 → 1 version BC / CB 3,0 bar 1 → 2 version AB / BA 3,0 bar 2 → 1 version AB / BA
Maximum volume flow	Q <sub>max</sub> = 150 l/min, see characteristics
Leakage oil	Poppet type, max. 0,15 ml / min (approx. 3 drops / min) at 30 cSt
Fluid	Mineral oil, other fluid on request
Viscosity range	12 mm <sup>2</sup> /s...320 mm <sup>2</sup> /s
Temperature range fluid	<b>Operation as T6</b> NBR -25...+40 °C (L9) FKM -20...+40 °C (L9) <b>Operation as T4</b> NBR -25...+70 °C (L9 or L15 / L17) FKM -20...+70 °C (L9 or L15 / L17) NBR 872 -40...+70 °C (L15 / L17)
Contamination efficiency	Class 20 / 18 / 14
Filtration	Required filtration grade β 10...16 ≥ 75, see data sheet 1.0-50

## ELECTRICAL SPECIFICATIONS

Protection class	IP65 / 66 / 67
Relative duty factor	100 % DF
Switching frequency	5'000 / h
Voltage tolerance	± 10 % with regard to nominal voltage
Standard nominal voltage	12 VDC, 24VDC, 115 VAC, 230 VAC AC = 50 to 60 Hz ± 2 %, with built-in two-way rectifier
Standard nominal power	9 W, 15 W, 17 W
Temperature class	Nominal power 9 W: T1...T6 Nominal power 15 W / 17 W: T1...T4

**Note!** Other electrical specifications see data sheet 1.1-183 and 1.1-184



## STANDARDS

Cartridge cavity	ISO 7789
Explosion protection	Directive 2014 / 34 / EU (ATEX)
Flameproof enclosure	EN / IEC / UL 60079-1, 31
Cable entry	EN 60079-0, 1, 7, 15, 31
Protection class	EN 60 529
Contamination efficiency	ISO 4406

## PERFORMANCE SPECIFICATIONS

Oil viscosity  $\nu = 30 \text{ mm}^2/\text{s}$

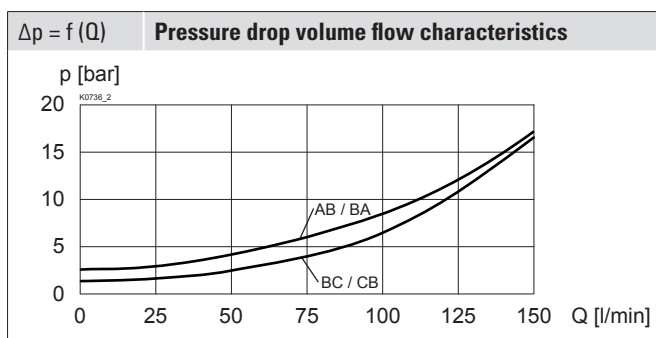
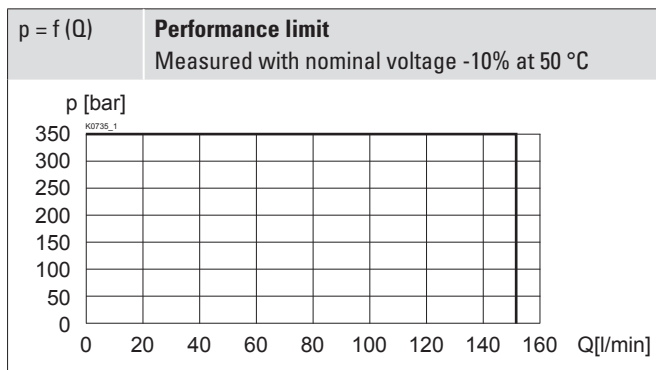

## SURFACE TREATMENT

- ◆ The cartridge body, the slip-on coil and the armature tube are zinc-nickel coated

Type	Switching times		
	Flow direction	Energised	De-energised
AB	1 → 2	approx. 100 ms	approx. 60 ms
	2 → 1	approx. 100 ms	approx. 80 ms
BA	1 → 2	approx. 30 ms	approx. 100 ms
	2 → 1	approx. 30 ms	approx. 100 ms
BC	2 → 1	approx. 30 ms	approx. 70 ms
CB	2 → 1	approx. 60 ms	approx. 70 ms

**Note!** With the L15 / L17 execution for ambient temperatures up to 70 °C, the characteristics have been evaluated with an ambient temperature of 50 °C.



The switching times depend on the volume flow, pressure and viscosity. In case of small volume flows, the switching time can get considerably longer.

**Attention!** Long periods of non-actuation can reduce the switching performance



## MANUAL OVERRIDE

Screw plug (HB0), no actuation possible.  
Optionally HN (K) or HG (K) (pushing) resp. HZ (K) (pulling)  
→ See data sheet 1.1-311

**Attention!** The manual override HZ (K) cannot be retrofitted.



## DIMENSIONS

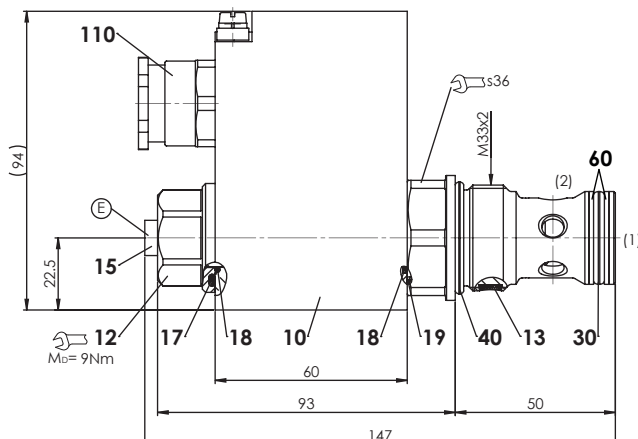

E = Air bleed screw

Dimensions of the solenoid coil see data sheet 1.1-183 and 1.1-184

## PARTS LIST

Position	Article	Description
10	263.6...	Solenoid coil MK.45 / 18 x 60
12	154.2603	Knurled nut Ex M18 x 1,5 x 18
13	212.0013	Plastic disc rd 7 x 1,5
15	239.2033	Screw plug HB0 (incl. seal)
110	111.1080	Cable gland M20 x 1,5
-	251.3009	Seal kit SV.PM33 NBR
-	251.3026	Seal kit SV.PM33 D1
-	251.3019	Seal kit SV.PM33 Z604

### Seal kit consisting of

17	O-ring	ID 25,07 x 2,62
18	O-ring	ID 17,17 x 1,78
19	O-ring	ID 26,00 x 1,00
30	O-ring	ID 23,81 x 2,62
40	O-ring	ID 29,82 x 2,62
60	Back. ring	PTFE rd 24,5 x 29 x 1,4

## COMMISSIONING

**Attention!** When commissioning, the valve must be vented under pressure (max. two rotations of screw E).



The solenoid coil must only be put into operation, if the requirements of the operating instructions supplied are observed to their full extent. In case of non-observance, no liability is assumed.

## HYDRAULIC CONNECTION

Cavity drawing according to ISO 7789-33-01-0-98

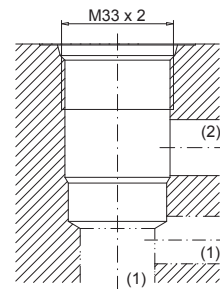

**Note!**



For detailed cavity drawing and cavity tools see data sheet 2.13-1005

## ACCESSORIES

Threaded body	Data sheet 2.9-2xx
Technical explanations	Data sheet 1.0-100
Filtration	Data sheet 1.0-50
Relative duty factor	Data sheet 1.1-430

## SEALING MATERIAL

NBR or FKM (Viton) as standard, choice in the type code

## INSTALLATION NOTES

Mounting type	Screw-in cartridge M33 x 2
Mounting position	Any, preferably horizontal
Tightening torque	$M_D = 130 \text{ Nm}$ Screw-in cartridge $M_D = 9 \text{ Nm}$ knurled nut

**Attention!**



For stack assembly please observe the remarks in the operating instructions