

Solenoid operated poppet valve cartridge

- ◆ solenoid operated
- ◆ direct operated
- ◆ normally open and normally closed
- ◆ 2/2-way
- ◆ $Q_{max} = 15 \text{ l/min}$
- ◆ $p_{max} = 250 \text{ bar}$

3/4"-16 UNF

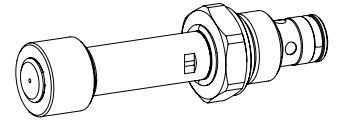

DESCRIPTION

Direct operated 2/2-way solenoid poppet valve in screw-in cartridge design for cavity according to Wandfluh standard. In case of the AB execution, the valve is closed in the energised position, in case of the BA execution in the de-energised position.

APPLICATION

Poppet valves are used where tight closing functions of the valve are essential like leakfree load holding, clamping or gripping. The poppet valve cartridge is mainly used in the mobile and stationary block construction.

SYMBOL

„Normally open“ AB

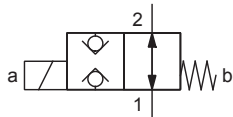

„Normally closed“ BA

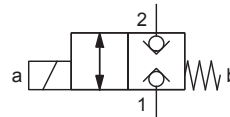

TYPE CODE

Poppet valve	S	D	E	PU08	-	<input type="text"/>	-	X5	#	<input type="text"/>
Direct operated										
Solenoid										
Screw-in cartridge 3/4"-16 UNF										
2/2 way, «normally open»						<input type="text" value="AB"/>				
2/2 way, «normally closed»						<input type="text" value="BA"/>				
Without coil										(The coil has to be ordered separately)
Design index (subject to change)										

1.11-205B

GENERAL SPECIFICATIONS

Designation	2/2-way poppet valve
Construction	Direct operated
Mounting	Screw-in cartridge type
Nominal size	3/4"-16 UNF
Actuation	Switching solenoid
Ambient temperature	-30...+110 °C
Weight	0,12 kg
MTTFd	150 years

HYDRAULIC SPECIFICATIONS

Working pressure	$p_{max} = 250 \text{ bar}$
Maximum volume flow	$Q_{max} = 15 \text{ l/min}$, see characteristics
Leakage volume flow	Seat tight, max. 5 drops / min at p_{max}
Fluid	Mineral oil, other fluid on request
Viscosity range	8 mm ² /s...420 mm ² /s
Temperature range	-20...+70 °C
Contamination efficiency	Class 20 / 18 / 14
Filtration	Required filtration grade $\beta_{10...16} \geq 75$, see data sheet 1.0-50

PERFORMANCE SPECIFICATIONS

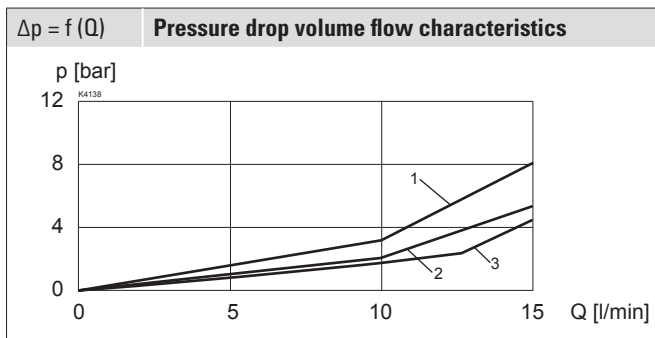
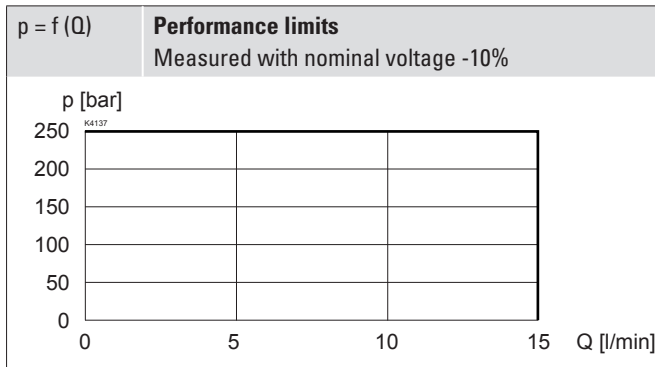
 Oil viscosity $\nu = 30 \text{ mm}^2/\text{s}$

Switching times

	Type	Switching on	Switching off
SDEPU08	AB	approx. 35 ms	approx. 80 ms
	BA	approx. 20 ms	approx. 40 ms

	AB	BA
de-energised 1 → 2	2	-
de-energised 2 → 1	3	-
energised 1 → 2	-	1
energised 2 → 1	-	1

DIMENSIONS

SDEPU08-AB / BA

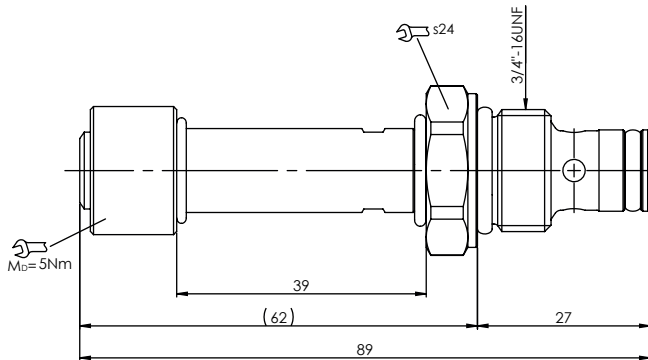

HYDRAULIC CONNECTION

Cavity drawing according to Wandfluh standard

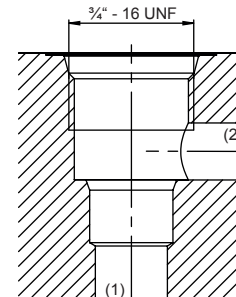

Note!



For detailed cavity drawing and cavity tools see data sheet 2.13-1043

ACCESSORIES

Technical explanations	data sheet 1.0-100
Hydraulic fluids	data sheet 1.0-50
Filtration	data sheet 1.0-50
Relative duty factor	data sheet 1.1-430

SURFACE TREATMENT

- ◆ The armature tube and the external parts of the cartridge body are zinc coated

STANDARDS

Protection class	EN 60 529
Contamination efficiency	ISO 4406

ACTUATION

Actuation	Switching solenoid, wet pin push + pull type, pressure tight
Execution	K.E33 / 13 x 39 (data sheet 1.1-160)
Connection	Connector socket EN 175301 – 803 Connector socket AMP Junior-Timer Connector Deutsch DT04 – 2P

Note!

The solenoid coil is not included in the delivery!



MANUAL OVERRIDE

None

INSTALLATION NOTES

Mounting type	Screw-in cartridge ¼"-16 UNF
Mounting position	Any, preferably horizontal
Tightening torque	M _D = 40-45 Nm for screw-in cartridge