

Proportional directional control valve

- Integrated amplifier or controller electronics
- Integrated spool position control with LVDT
- Direct operated, not pressure compensated
- $Q_{max} = 27$ l/min
- $Q_{Nmax} = 20$ l/min
- $p_{max} = 350$ bar

NG6
 ISO 4401-03

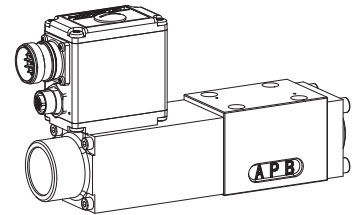

DESCRIPTION

Direct operated proportional spool valve with integrated electronics in flange design NG6 acc. to ISO 4401-03/7790 with 4 ports. The valve possesses an integrated positional control of the valve spool. This assures a minimal hysteresis and improved dynamic characteristics. Housing for electronics with protection class IP67 for harsh environment. The spool valve is designed acc. to the 5 chamber principle. The volume flow is adjusted by Wandfluh proportional solenoids (VDE standard 0580). Low pressure drop due to the body design and spool profiling. The spool is made of hardened steel. The body made of high grade hydraulic casting is painted. The solenoids are zinc coated and the housing for the electronics is made of aluminium.

FUNCTION

With the integrated spool position sensor (LVDT) the actual position of the spool is continuously recorded and made to follow the set-point value transmitted in an analogue manner. By means of this internal positional control, a minimal hysteresis and excellent dynamic characteristics are assured. With an increasing command value signal, the valve opening and therefore the volume flow changes. With 50 % of the solenoid current, the centre of the spool position (PTAB closed) is reached. In the case of an electric power failure, the spool by means of the spring force shifts into the basic position. Parameter setting and diagnosis with the free-of-charge software «PASO». Data are stored in a non volatile memory. Even after an electric power failure settings can easily be reproduced and transmitted. These valves are available with an integrated controller as an option. As feedback signal source sensors with voltage or current output signal can be directly connected. The available controller structure has been optimised for applications with hydraulic actuators.

APPLICATION

Proportional directional control valves with integrated electronics are highly suitable for demanding applications thanks to a high resolution, large volume flow, minimal hysteresis and very good dynamic characteristics. They are implemented in systems calling for good valve-to-valve reproducibility, easy installation, comfortable operation and high precision in industrial hydraulics as well as in mobile hydraulics for the smooth control of actuators. The integrated controller relieves the machine control system and operates the axis (position, angle, pressure, etc.) in a closed control loop. Application examples: pitch control of wind generators, forest and earth moving machines, machine tools and paper production machines with position controls, robotics and fan control.

TYPE CODE

 WD R F A06 - - - - 24 - #

Directional control valve, direct operated

Proportional valve with integrated electronics

Flange version

International standard interface ISO, nominal size 6

Designation of symbols acc. to table 1.10-83/2

 Nominal volume flow ranges Q_N : 10 l/min ACB1-S only 20 l/min ACB1-R only

 Standard nominal voltage U_N : 24 VDC

Hardware configuration:

With analog signal (-10...+10 V voreingestellt)

 A2

With CANopen acc. to DSP-408

 C1

With Profibus DP in accordance with Fluid Power Technology

 P1

Functions:

Amplifier

 no remark

Controller with current feedback signal (0...20 mA / 4...20 mA)

 R1

Controller with voltage feedback signal (0...10 V)

 R2

Design-Index (Subject to change)

GENERAL SPECIFICATIONS

Designation	4/3-way proportional valve with integrated electronics	Ambient temperature	-20...+65 °C (typical) (The upper temperature limit is a guideline value for typical applications, in individual cases it may also be higher or lower. The electronics of the valve limit the power in case of a too high electronics temperature. More detailed information can be obtained from the operating instructions «DSV».)
Nominal size	NG6-Mini acc. to ISO 4401-03/7790	Mounting position	any, preferably horizontal
Construction	Direct operated spool valve	Fastening torque	$M_D = 5,5$ Nm (quality 8.8)
Operations	Proportional solenoid, wet pin push type, pressure tight	Weight	$m = 2,65$ kg
Mounting	Flange, 4 fixing holes for socket head cap screws M5x50		
Connections	Threaded connection plates, multi-flange subplates, longitudinal stacking system		

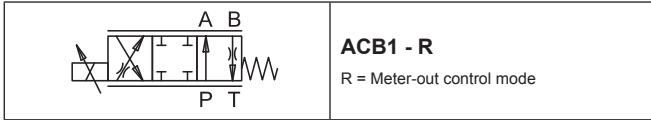
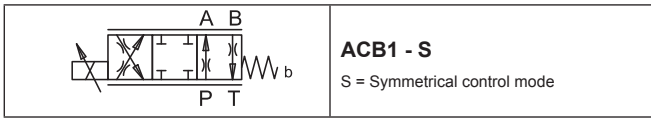
TYPE CHARTS/DESIGNATIONS OF SYMBOLS

HYDRAULIC SPECIFICATIONS

Fluid	Mineral oil, other fluid on request
Contamination efficiency	ISO 4406:1999, class 18/16/13 (Required filtration grade $\beta_{6...10} \geq 75$) refer to data sheet 1.0-50/2
Viscosity range	12 mm ² /s...320 mm ² /s
Fluid temperature	-20...+70 °C
Working pressure	$p_{max} = 350 \text{ bar}$ (connections P, A, B)
Tank pressure	$p_{max} = 160 \text{ bar}$ (connections T)
Nominal volume flow	$Q_N = 10 \text{ l/min}, 20 \text{ l/min}$,
Max. volume flow	see characteristic
Leakage volume flow	on request
Hysteresis	< 0,4 %
Repeatability	< 0,4 %
Jump response	typically 25 ms from 10 to 90 %

ELECTRICAL SPECIFICATIONS

Protection class	IP 67 acc. to EN 60 529 with suitable connector and closed electronic housing
Supply voltage	24 VDC
Ramps (amplifier only)	separate adjustment for up and down for each solenoid
Preset value generator (controller only)	preset value speed adjustable
Parameterisation	via fieldbus or USB
Interface	USB (Mini B) for parameterisation with «PASO» (under the closing screw of the housing cover, factory set parameters)

Analog interface

Device receptacle (male)	M23, 12-poles
Mating connector	Plug (female), M23, 12-poles (not incl. in delivery)
Preset value signal:	Voltage/ current selected with software

Fieldbus interface:

Device receptacle supply (male)	M12, 4-poles
Mating connector	Plug (female), M12, 4-poles (not incl. in delivery)
Device receptacle CANopen (male)	M12, 5-poles (acc. to DRP 303-1)
Mating connector	Plug (female), M12, 5-poles (not incl. in delivery)
Device receptacle Profibus (female)	M12, 5-poles, B-codiert (acc. to IEC 947-5-2)
Mating connector	Plug (male), M12, 5-poles, B-codiert (not incl. in delivery)
Preset value signal:	Fieldbus

NOTE!

Detailed electrical characteristics and description of «DSV» electronics are shown on data sheet **1.13-75**.

START-UP

Normally there is no need to adjust settings by the customer. The connectors have to be wired according to the chapter «Connector wiring diagram».

Controllers will be supplied configured as amplifiers. Switching into controller mode and setting of the adjustments of the controller must be done by the customer using the set-up software (USB interface, Mini B).

Additional information can be found on our website:

«www.wandfluh.com»

Free-of-charge download of the «PASO»-software and the instruction manual for the «DSV» hydraulic valves as well as the operation instruction **CANopen** protocol with device profile DSP-408 for «DSV».

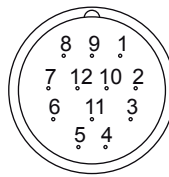
CONNECTOR WIRING DIAGRAM
Analog interface:
Device receptacle (male) X1

- 1 = Supply voltage +
- 2 = Supply voltage 0 VDC
- 3 = Stabilised output voltage
- 4 = Preset value voltage +
- 5 = Preset value voltage -
- 6 = Preset value current +
- 7 = Preset value current -
- 8 = Reserved for extensions
- 9 = Reserved for extensions
- 10 = Enable control (Digital input)
- 11 = Error signal (Digital output)
- 12 = Chassis

Preset value voltage (PIN 4/5) resp. current (PIN 6/7) are selected with set-up and diagnosis software.

Factory setting: Voltage (-10...+10 V), (PIN 4/5)

Fieldbus interface:
Device receptacle supply (male) X1
MAIN

- 1 = Supply voltage +
- 2 = Reserved for extensions
- 3 = Supply voltage 0 VDC
- 4 = Chassis

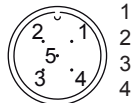
Device receptacle CANopen (male) X3

CAN

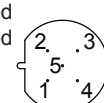
- 1 = not connected
- 2 = not connected
- 3 = CAN Gnd
- 4 = CAN High
- 5 = CAN Low

Device receptacle Profibus (female) X3

PROFIBUS

- 1 = VP
- 2 = Rx/D / Tx/D - N
- 3 = DGND
- 4 = Rx/D / Tx/D - P
- 5 = Shield

Parameterisation interface (USB, Mini B) X2

Under the closing screw of the housing cover

Feedback signal interface
Device receptacle Sensor (female) X4 (controller only)



- 1 = Supply voltage (output) +
- 2 = Feedback signal +
- 3 = Supply voltage 0 VDC
- 4 = not connected
- 5 = stab. output voltage

NOTE!

The mating connector and the cable to adjust the settings are not part of the delivery. To order the cable, look up the article no. in the chapter «Accessories».

CHARACTERISTICS Oil viscosity $\nu = 30 \text{ mm}^2/\text{s}$

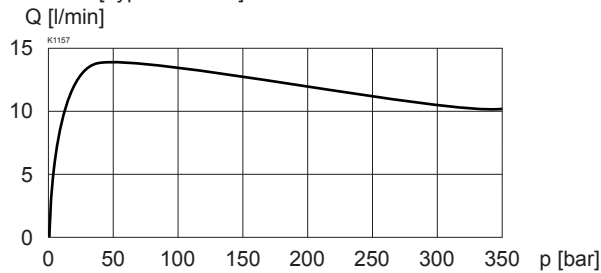
$Q = f(p)$ Volume flow pressure characteristics ($s = 100\%$)
 [Type: ACB1-S]



$\Delta p = f(Q)$ Pressure loss/flow characteristics ($s = 100\%$)
 [Type: ACB1-S]

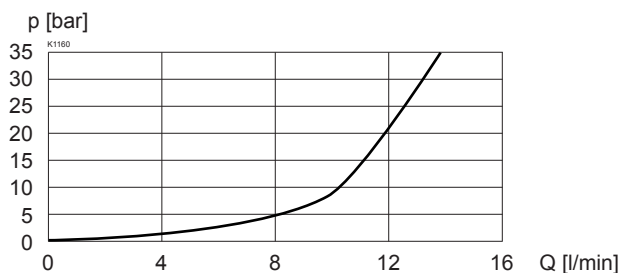

$Q = f(s, x)$ Volume flow-signal-characteristics ($\Delta p = 10 \text{ bar}$)
 [Type: ACB1-S]
 (s corresponds to preset value signal and x corresponds to spool stroke)

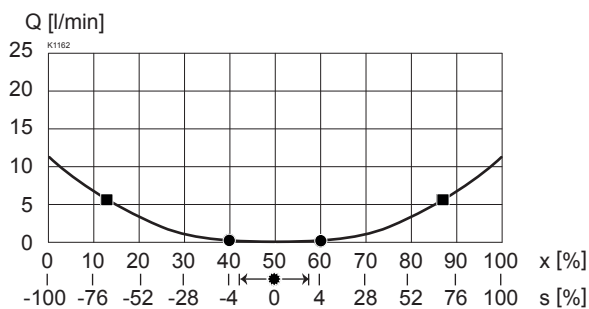

Factory settings:

- ☛ = Deadband: 50% of the solenoid current with command signal -2%...+2%
- = Opening point: at command signal $\pm 4\%$
- = Flow at $\Delta p = 10 \text{ bar}$ over 2 metering edges at command signal $\pm 70\%$

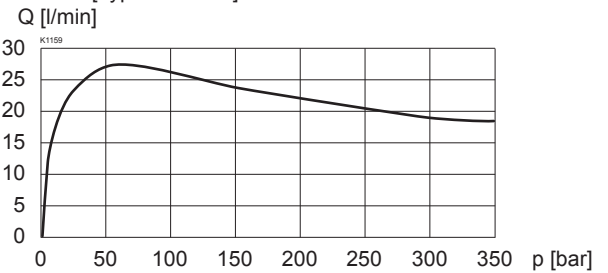
$Q = f(p)$ Volume flow pressure characteristics ($s = 100\%$)
 [Type: ACB1-R]

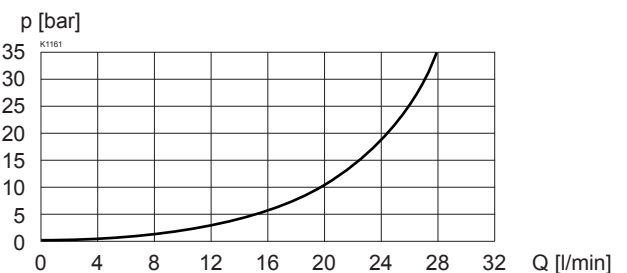

$\Delta p = f(Q)$ Pressure loss/flow characteristics ($s = 100\%$)
 [Type: ACB1-R]

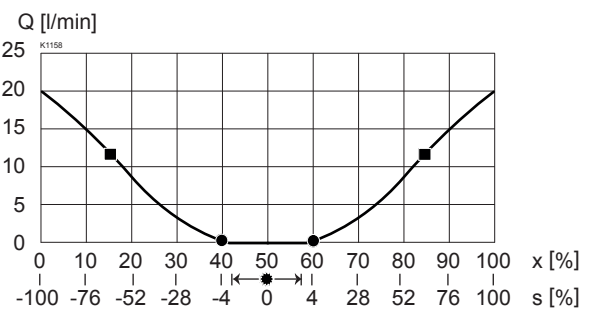

$Q = f(s, x)$ Volume flow-signal-characteristics ($\Delta p = 10 \text{ bar}$)
 [Type: ACB1-R]
 (s corresponds to preset value signal and x corresponds to spool stroke)

Factory settings:

- ☛ = Deadband: 50% of the solenoid current with command signal -2%...+2%
- = Opening point: at command signal $\pm 4\%$
- = Flow at $\Delta p = 10 \text{ bar}$ over 2 metering edges at command signal $\pm 70\%$



NOTE!

All values measured over 2 metering edges, A and B ports linked.

DIMENSIONS
With analog interface
 Amplifier and controller

NOTE!

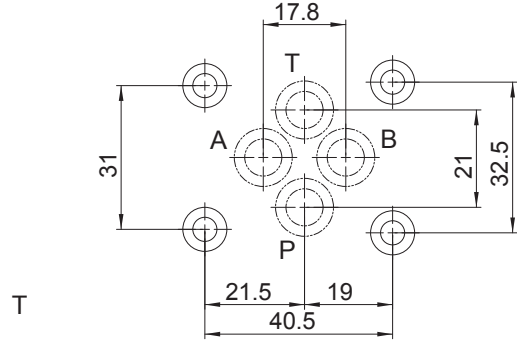
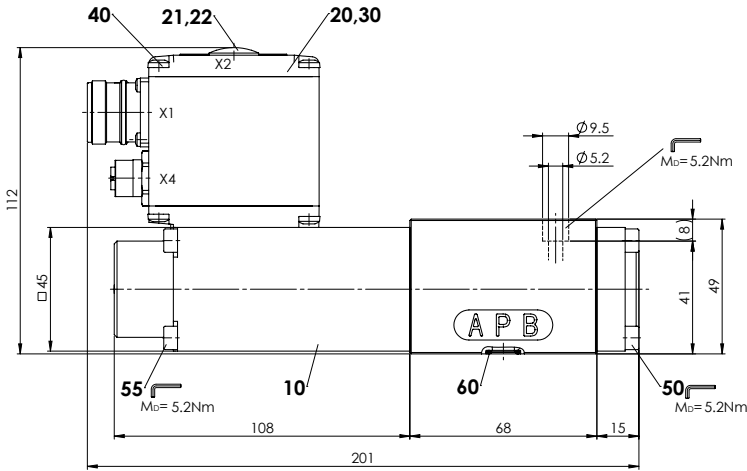
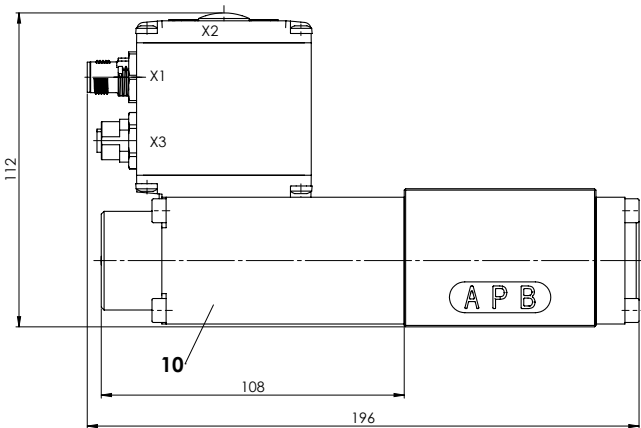
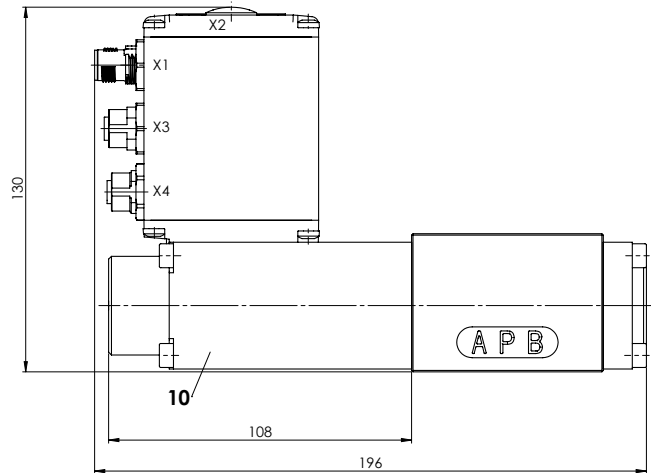
The cable connector is not part of the delivery. The dimensions refer to those of the cable connector in the chapter «Accessories».

With fieldbus interface
 Amplifier

With fieldbus interface
 Controller

PARTS LIST

Position	Article	Description
20	062.0102	Cover
21	223.1317	Dummy plug M16x1,5
22	160.6131	O-ring ID 13,00x1,5
30	072.0021	Gasket 33x2x59,9x2
40	208.0100	Socket head cap screw M4x10
50	246.2117	Socket head cap screw M5x16 DIN 912
55	246.2190	Socket head cap screw M5x90 DIN 912
60	160.2093	O-ring ID 9,25x1,78

ACCESSORIES

- Set-up software see start-up
- Cable to adjust the settings through interface USB
(from plug type A to Mini B, 3 m) article no. 219.2896
- Cable connector for analog interface:
 - straight, soldering contact article no. 219.2330
 - 90°, soldering contact article no. 219.2331
 Recommended cable size:
 - Outer diameter 9...10,5 mm
 - Single wire max. 1 mm²
 - Recommended wire size:
 - 0...25 m = 0,75 mm² (AWG18)
 - 25...50 m = 1 mm² (AWG17)

Technical explanation see data sheet 1.0-100